

PATRIOT™

INTELLIGENT FENCING FOR THE COUNTRY



FLEXIBILITY

DESIGN

VALUE



P5

P10

P20

P30

USER MANUAL

WARNING: READ ALL INSTRUCTIONS
ATTENTION! LIRE ATTENTIVEMENT TOUTES LES INSTRUCTIONS

Contents

Your Patriot electric fence charger ..	1
Installation	2
Building an electric fence.....	3
Safe electric fence construction	7
Safety information.....	8
Definition of special terms.....	8
Requirements for electric animal fences.....	9
Frequently asked questions/ Troubleshooting	11
Servicing.....	12
Product specifications	12
12 month warranty from date of purchase.....	13

© 2009 Tru-Test Limited

All product names and brand names in this document are trademarks or registered trademarks of their respective holders.

No part of this publication may be photocopied, reproduced, stored in a retrieval system, or transmitted in any form or by any means, electronic, mechanical, photocopying, recording or otherwise without the prior written permission of Tru-Test Limited. Product specifications may change without prior notice.

For more information about the Patriot range of quality products, see www.patriotglobal.com.

Tru-Test Inc	Tru-Test Ltd
528 Grant Road	25 Carbine Rd
Mineral Wells	Mt Wellington
Texas 76067	Auckland
USA	New Zealand

813243 Issue 1 5/09

Models covered by this manual

This manual covers various charger models: P5, P10, P20, P30

Your Patriot electric fence charger

Congratulations on your purchase of this quality Patriot electric fence charger. Patriot electric fence chargers are manufactured in New Zealand by the world's leading electric fencing company, Tru-Test Ltd, and are the product of over 65 years of electric fencing experience. An extremely versatile charger, the Patriot is ideally suited to control all types of livestock. The charger is highly effective for controlling predators and can even be used for pet management. This "go-anywhere" electric fence charger is also perfect for intensive strip grazing.

Using the power adapter supplied, the charger can be connected to 110 V electrical outlet. Alternatively, by using the battery lead supplied, it can also be powered by a 12 V battery. The electric fence charger can even be plugged into your vehicle's cigarette lighter socket, for fencing horses when traveling or trail riding (separate lead required).

Parts of the electric fence charger

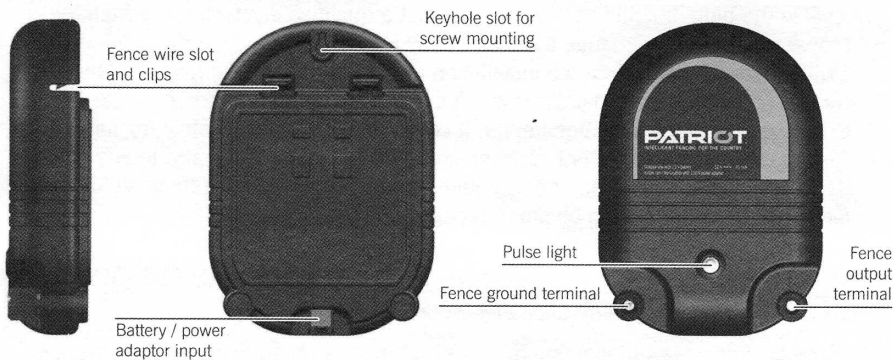

Key to symbols on the electric fence charger



Fence ground terminal. Connect the fence ground terminal to the ground system.



Fence output terminal. Connect the fence output terminal to the fence.



Risk of electric shock! This energizer is not repairable and should not be opened.



Read full instructions before use.



This symbol on the product or its packaging indicates that this product must not be disposed of with other waste. Instead, it is your responsibility to dispose of your waste equipment by handing it over to a designated collection point for the recycling of waste electrical and electronic equipment. The separate collection and recycling of your waste equipment at the time of disposal will help conserve natural resources and ensure that it is recycled in a manner that protects human health and the environment. For more information about where you can drop off your waste equipment for recycling, please contact your local city recycling office or the dealer from whom you purchased the product.



The energizer has a double-insulated construction. No serviceable parts.

WARNING!

- USA and Canada - To reduce the risk of electric shock, the energizer's power adaptor may have a polarized plug (one blade is wider than the other). This plug will fit in a polarized outlet one way. If the plug does not fit fully in the outlet, reverse the plug. If it still does not fit, contact a qualified electrician to install the proper outlet. Do not change the plug in any way.
- Switch the energizer off before installation or performing any work on the fence.
- Read all the safety considerations carefully. See *Safety Information* on page 7.
- Check your installation to ensure that it complies with all local safety regulations.
- Risk of electric shock! Do not connect simultaneously to a fence and to any other device such as a cattle trainer or a poultry trainer. Otherwise, lightning striking your fence will be conducted to all other devices.

ATTENTION! *Risque de choc électrique*

Ne jamais connectez simultanément à une clôture et à un autre appareil de gestion de troupeau comme par exemple un nourrisseur automatique pour bovins ou poulets. Sinon, un coup de foudre qui frappe votre clôture sera transmis à tout autre appareil branché.

Note:

- This product has been designed for use with electric animal fences.
- Keep these instructions in a handy location.

Installation

Warning!

- Disconnect power before making changes to fence or ground wiring
- Mount out of reach of children.

- 1 Connect the Fence output terminal to the fence.
- 2 Connect the Fence ground terminal to a separate ground system that is at least 33' (10 m) away from other ground systems.

12 V battery

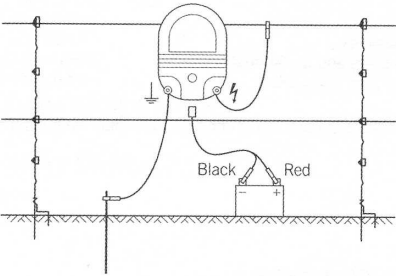

Only use the battery lead supplied with your charger, or a genuine Patriot replacement (part number 807396).

110 V power adapter

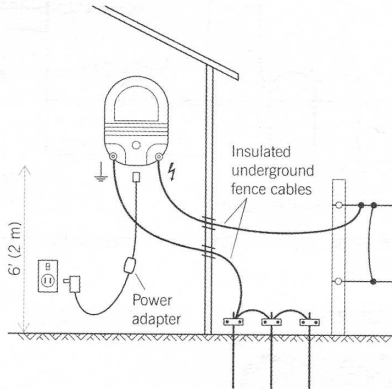

Only use the power adapter supplied with your electric fence charger, or a genuine Patriot replacement (part number 804129).

See *Safety information* on page 8 for power adapter care instructions.

Building an electric fence

For information about building an electric fence, refer to the Patriot website www.patriotglobal.com.

Permanent fence construction

You need:

Insulators

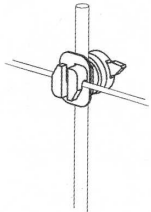

Steel rod post

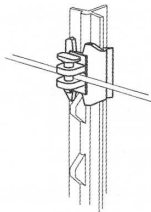

Steel T post

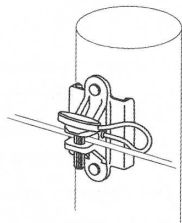

Steel T post / Wood post pinlock

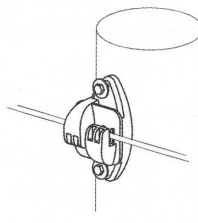

Wood post claw

Typical fence construction

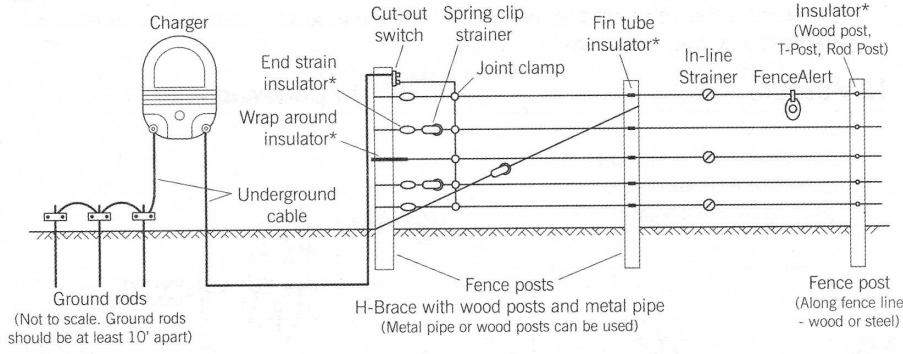

* A single type of insulator can be used on the fence line or a mixture of each depending on individual needs and post type.

Strainers

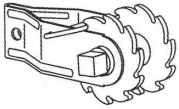

Tension to no more than 200 lb (90 kg)

Recommended fence construction

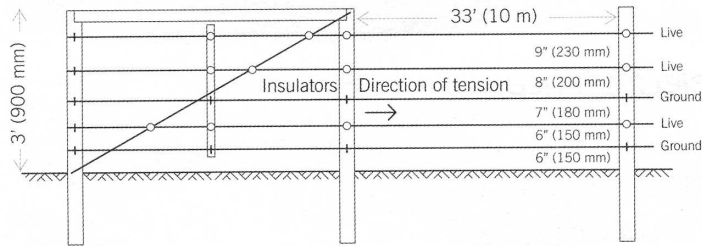

H-Brace – Very simple to erect and most suitable as a high tension strainer, excellent in areas where the soil gets very wet or where heavy frost occurs.

Temporary fence construction

Recommended wire spacing

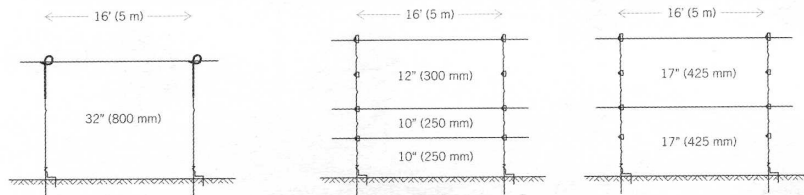

Dairy cattle

Sheep

Cattle

Typical fence construction

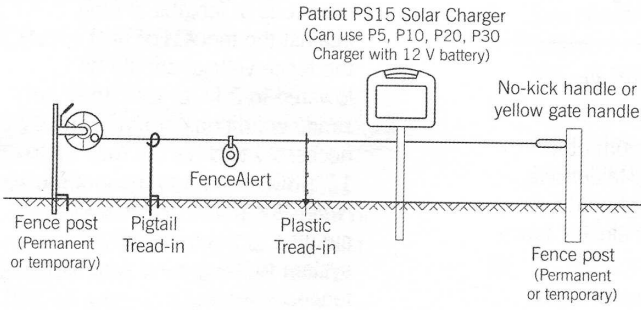

Grounding a fence

All live fence

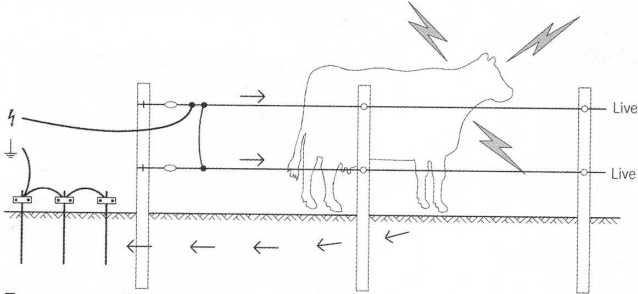

For most soil types.

The animal receives a shock when it completes a circuit between the fence and the ground system. The fence above has all live wires and requires conductive soils.

Ground wire return fence

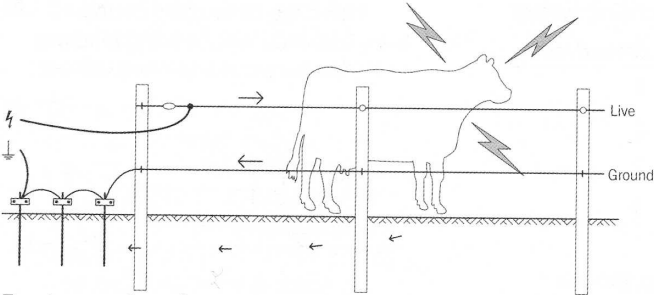

For dry, sandy or frozen ground conditions, where soil conductivity is low.

The animal receives a shock when it completes a circuit between a live wire and a ground wire. The fence above has both live wires and ground wires (not insulated to the post). The ground wire is connected back to the grounding system.

Installing and testing a ground system

Select a suitable site for the ground system. Sites need to be:

- At least 33' (10 m) from other ground systems (e.g. telephone, 110 V power or the ground system from another electric fence charger).
- Away from stock or other traffic that could interfere with the installation.
- At a site that can be easily observed for maintenance.
- Ideally at a site that has damp soil (e.g. a shaded or swampy location). Note that the ground does not need to be directly adjacent to the electric fence charger installation.

Drive ground rods into the soil. Use high-voltage, insulated cable and ground clamps to continuously connect the ground rods and the charger's Fence ground terminal. Make sure the insulation is stripped back to ensure good contact between the wire and the ground rod. The table below specifies the minimum number of ground rods recommended for a grounding system:

<u>Electric fence charger</u>	<u>Ground rods</u>
P5	1
P10	1
P20	2
P30	3

For an all live fence only, test the ground system using the following procedure:

- 1 Turn off the electric fence charger.
- 2 At least 330' (100 m) away from the electric fence charger, short-

circuit the fence by laying several steel rods or lengths of pipe against the fence. For best results, the fence voltage should be lowered to 2 kV or less. In dry or sandy conditions, it may be necessary to drive the rods up to 12" (300 mm) into the ground.

Note: It is not acceptable to short-circuit a ground wire return system to the ground wire of the fence.

- 3 Turn the electric fence charger back on.
 - 4 Using a digital voltmeter, ensure that the fence voltage is below 2 kV.
 - 5 Check your ground system. Insert the voltmeter's ground probe into the ground at the full extent of the lead, and hold the other terminal against the last ground rod. The tester should not read more than 0.3 kV. Anything higher than this indicates that better grounding is required. Either add more ground rods or find a better ground area to drive in the ground rods.
- Note:* When grounding electric fence chargers located in dairies, ground at least 65' (20 m) away from the dairy using double-insulated wire to avoid touching the dairy building or equipment.

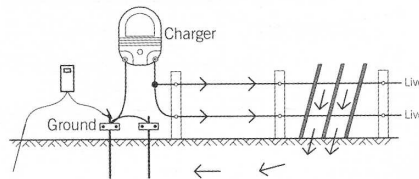

Safe electric fence construction

WARNING! Read before use.

An electric fence can be hazardous when there is a risk of entrapment or entanglement, or other hazards exist. Serious injury or death may result. Take all steps to avoid the risk of entrapment or entanglement. This safety information should be read in conjunction with *Requirements for electric animal fences* on page 9.

Hazards

- ☒ Do not climb through or under an electric fence. If it is necessary to cross an electric fence use a gate or specially designed crossing point.
- ☒ Do not allow young or infirm persons to use this electric fence charger without supervision. Do not allow young children to play with this charger or near an electric fence or electrified wires.
- ☒ Do not electrify barbed wire.
- ☒ Do not support off-set electrified wires less than 6" (150 mm) from a barbed wire fence.
- ☒ Do not electrify any fence construction which could lead to entanglement of persons or animals. We recommend for instance, that no more than one electrified off-set wire be supported on either side of a barbed wire or mesh fence.
- ☒ Do not supply an electric fence from two chargers.

- ☒ Do not allow electrified wires from two chargers on the same or adjacent properties to be less than 6'6" (2 m) apart.
- ☒ Do not place charger ground electrodes within 33' (10 m) of any part of a power supply ground system or telecommunications ground system.
- ☒ Do not run electric fence wires above or close to overhead power or communication lines.

Duty to the public

Fasten warning signs to electric fence posts or wires at frequent intervals along any public roads or pathways. Incorporate a non-electrified gate or stile where an electric animal fence crosses a public pathway and fasten warning signs to fence posts or wires adjacent to the crossing.

For more information, contact Patriot or your local Patriot dealer. Refer to www.patriotglobal.com for contact details.

Safety information

Power adapter - Important safety instructions

When using electrical products, basic precautions should always be practiced including the following:

- 1 **READ AND FOLLOW ALL SAFETY INSTRUCTIONS.**
- 2 Read and follow all instructions provided with the electric fence charger and power adapter.
- 3 Do not use an extension cord with the power adapter.
- 4 Refer to the National Electrical Code ANSI/NFPA 70 for information about the installation of wiring and clearances from power and lighting conductors.
- 5 Installation work and electrical wiring must be done by qualified person(s) in accordance with all applicable codes and standards, including fire-rated construction.
- 6 Do not install or use within 10 feet (3 m) of a pool.
- 7 Do not use in a bathroom.
- 8 **WARNING:** Risk of electric shock. When used outdoors or in a wet location, install only to a covered Class A GFCI protected receptacle that is weatherproof with the power adapter connected to the receptacle. If a correct GFCI protected receptacle is not currently installed, contact a qualified electrician for proper installation. Ensure that nothing

interferes with completely closing the receptacle cover.

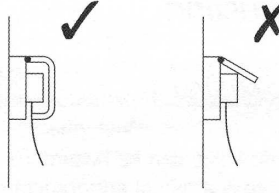

- 9 **WARNING:** Risk of fire. Installation involves special wiring methods to run wiring through a building structure. Consult a qualified electrician.

Definition of special terms

Electric fence charger/Charger – An appliance that is intended to periodically deliver voltage impulses to a fence connected to it.

Fence – A barrier for animals or for the purpose of security, comprising one or more conductors such as metal wires, rods or rails.

Electric fence – A barrier that includes one or more electric conductors, insulated from ground, to which electric pulses are applied by an electric fence charger.

Ground electrode – Metal structure that is driven into the ground near an electric fence charger and connected electrically to the output Fence ground terminal of the electric fence charger, and that is independent of other grounding arrangements.

Connecting lead – An electric conductor, used to connect the electric fence charger to the electric fence or the ground electrode.

Requirements for electric animal fences

Electric animal fences and their ancillary equipment shall be installed, operated and maintained in a manner that minimizes danger to persons, animals or their surroundings.

Warning! Avoid contacting electric fence wires especially with the head, neck or torso. Do not climb over, through or under a multi-wire electric fence. Use a gate or a specially designed crossing point.

This electric fence charger is not intended for use by young children or by infirm persons without supervision.

Young children should be supervised to ensure that they do not play with the charger.

Electric animal fence constructions that are likely to lead to the entanglement of animals or persons shall be avoided.

An electric animal fence shall not be supplied from two separate electric fence chargers or from independent fence circuits of the same electric fence charger.

For any two separate electric animal fences, each supplied from a separate electric fence charger independently timed, the distance between the wires of the two electric animal fences shall be at least 6'6 (2 m). If this gap is to be closed, this shall be effected by means of electrically non-conductive material or an isolated metal barrier.

Barbed wire or razor wire shall not be electrified by an electric fence charger.

A non-electrified fence incorporating barbed wire or razor wire may be used to support one or more offset electrified

wires of an electric animal fence. The supporting devices for the electrified wires shall be constructed so as to ensure that these wires are positioned at a minimum distance of 6" (150 mm) from the vertical plane of the non-electrified wires. The barbed wire and razor wire shall be grounded at regular intervals. Go to www.patriotglobal.com for information regarding grounding.

A distance of at least 33' (10 m) shall be maintained between the electric fence charger ground electrode and any other grounding system connected parts such as the power supply system protective ground or the telecommunication system ground.

Connecting leads that are run inside buildings shall be effectively insulated from the grounded structural parts of the building. This may be achieved by using insulated high voltage cable.

Connecting leads that are run underground shall be run in conduit of insulating material or else insulated high voltage cable shall be used. Care must be taken to avoid damage to the connecting leads due to the effects of animal hooves or vehicle wheels sinking into the ground.

Connecting leads shall not be installed in the same conduit as mains supply wiring, communication cables or data cables.

Connecting leads and electric animal fence wires shall not cross above overhead power or communication lines.

Crossings with overhead power lines shall be avoided wherever possible. If such a crossing cannot be avoided it shall be made underneath the power line and as nearly as possible at right angles to it.

If connecting leads and electric animal fence wires are installed near an overhead power line, the clearances shall not be less than those shown in the table below.

Minimum clearances from power lines for electric animal fences:

<i>Power line voltage</i>	<i>Distance</i>
≤1000 V	10' (3 m)
>1000 to ≤33,000 V	13' (4 m)
>33,000 V	14' (8 m)

If connecting leads and electric animal fence wires are installed near an overhead power line, their height above the ground shall not exceed 10' (3 m). This height applies to either side of the orthogonal projection of the outermost conductors of the power line on the ground surface, for a distance of:

- 6'6" (2 m) for power lines operating at a nominal voltage not exceeding 1000 V.
- 50' (15 m) for power lines operating at a nominal voltage exceeding 1000 V.

Electric animal fences intended for deterring birds, household pet containment or training animals such as cows need only be supplied from low output electric fence chargers to obtain satisfactory and safe performance.

In electric animal fences intended for deterring birds from roosting on buildings, no electric fence wire shall be connected to the electric fence charger ground electrode.

A warning sign shall be fitted to every point where persons may gain ready access to the conductors.

Where an electric animal fence crosses a public pathway, a non-electrified

gate shall be incorporated in the electric animal fence at that point or a crossing by means of stiles shall be provided. At any such crossing, the adjacent electrified wires shall carry warning signs.

Any part of an electric animal fence that is installed along a public road or pathway shall be identified at frequent intervals by warning signs securely fastened to the fence posts or firmly clamped to the fence wires.

- The size of the warning sign shall be at least 4x8" (100x200 mm).
- The background color of both sides of the warning sign shall be yellow. The inscription on the sign shall be black and shall be either:

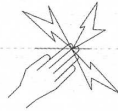

or the substance of "CAUTION: Electric Fence".

- The inscription shall be indelible, inscribed on both sides of the warning sign and have a height of at least 1" (25 mm).

Ensure that all mains-operated, ancillary equipment connected to the electric animal fence circuit provides a degree of isolation between the fence circuit and the supply mains equivalent to that provided by the electric fence charger.

Protection from the weather shall be provided for the ancillary equipment unless this equipment is certified by the manufacturer as being suitable for use outdoors, and is of a type with a minimum degree of protection IPX4.

Frequently asked questions/ Troubleshooting

How do I increase fence voltage?

Sometimes recent extensions to your fence, a poor fence layout, or soil conditions may be causing inadequate voltage.

To check the electric fence charger, disconnect it from the fence and the ground system. Measure the voltage across the electric fence charger terminals with a digital voltmeter. If the voltage is less than 6 kV your electric fence charger may be faulty. Go to www.patriotglobal.com for more details.

How do I locate faults?

The most common cause of low voltage is faults on the fence line. Faults can be arcing faults that often make a clicking sound that can be heard when walking along a fence line. These are most often caused by faulty insulators or poor connections (loose clamps, tied wires or faulty cutout switches) and are normally fixed by replacing the faulty insulator or repairing the faulty connections. Note: Always use specially made joining clamps or crimps to secure wire to wire connections on the fence line.

Another fault type is a short circuit fault. This fault occurs when a live fence wire becomes connected in some way to the ground. A short circuit fault wastes the power of the electric fence charger by drawing energy away from where it is needed, the fence line. A common cause of short circuit faults is vegetation touching the live wires.

Regular clearing of vegetation from the fence line will enhance your electric fence charger's performance. The best method to locate a short circuit fault is to use a special fault finder. These products save considerable time by directing you straight to the fault. Go to www.patriotglobal.com for more details.

Another tool used to locate faults is a digital voltmeter. When using a digital voltmeter, simply isolate sections of your fence by opening cut-out switches or otherwise disconnecting sections of the fence from the main lead out wire/s. Measure the voltage and determine whether the voltage has improved. If after disconnecting a section of the fence you record a significant improvement in fence voltage, it is likely that the fault is located in the section of fence that you have just isolated. Often a visual inspection of the faulty section will reveal the problem.

By carrying your voltmeter or fault finder when you move around the farm you can regularly test your fence system and fix faults before they lead to or result in a larger problem.

There are no lights flashing on the electric fence charger

Check the power supply. If fence charger is connected to line power adapter, ensure that the power is switched on. Disconnect the power then reconnect the power 30 seconds later.

If fence charger is connected to a 12 V battery, ensure that the positive (red) clip is connected to the positive terminal on the battery and the negative (black) clip is connected to the negative terminal on the battery.

If the fence charger's pulse light still does not flash, disconnect the battery then reconnect the battery 30 seconds later. Also, check the battery voltage.

If the fence charger still does not operate, refer to your warranty conditions.

Servicing

This product cannot be serviced. Please refer to your warranty conditions.

Service of double insulated appliances

In a double insulated electric fence charger, two systems of insulation are provided instead of grounding. Patriot chargers contain no serviceable parts.

Product specifications

	<i>P5</i>	<i>P10</i>	<i>P20</i>	<i>P30</i>
	15 miles/ 60 acres	30 miles/ 100 acres	50 miles/ 200 acres	65 miles/ 260 acres
Input voltage	12 V, 45 mA	12 V, 90 mA	12 V, 170 mA	12 V, 300 mA
Peak output energy	up to 0.5 J	up to 1 J	up to 2 J	up to 3 J
Stored energy	up to 0.7 J	up to 1.3 J	up to 2.7 J	up to 4.6 J
Output voltage	8.0 kV max, 4.5 kV at 500 Ω	9.7 kV max, 5.4 kV at 500 Ω	10.5 kV max, 6.0 kV at 500 Ω	11.0 kV max, 6.4 kV at 500 Ω

Table represents typical values

12 month warranty

from date of purchase

This warranty does not cover defects caused by:

- Incorrect input voltage or polarity
- Damage to external wiring
- Physical mishandling
- Water immersion
- Vermin or insect damage
- Battery leakage or chemicals

Note: This product has been manufactured to comply with international safety standards.

Tru-Test and its agents accept no responsibility for any accident caused subsequent to any tampering with or modification or misuse of this product, including repairs or alterations made by anyone other than Tru-Test or its agents.

No conditions, warranties or guarantees, statutory or otherwise, whether oral or in writing (other than this service warranty), shall attach to this product and its sale and purchase, other than that it will be delivered in good working condition.

The details below must be properly completed by the dealer at the time of purchase.

This product is warranted against faulty material and workmanship for a period of 12 calendar months FROM DATE OF PURCHASE.

If any warranted defect occurs during the warranty period, return the product with proof of purchase to your local Patriot dealer, distributor, or directly to the manufacturer. Protect your investment by completing this warranty card today and mailing it to:

Tru-Test Inc. 528 Grant Road,
Mineral Wells, TX 76067

Model:	Serial number:
Name of owner:	
Address:	
Date of purchase:	
Dealer contact details: (must be completed by dealer)	



This product is warranted against lightning strike

PATRIOT™

INTELLIGENT FENCING FOR THE COUNTRY

SAVE THESE INSTRUCTIONS

www.patriotglobal.com