

OPERATING INSTRUCTION

Electric Fence Energizer

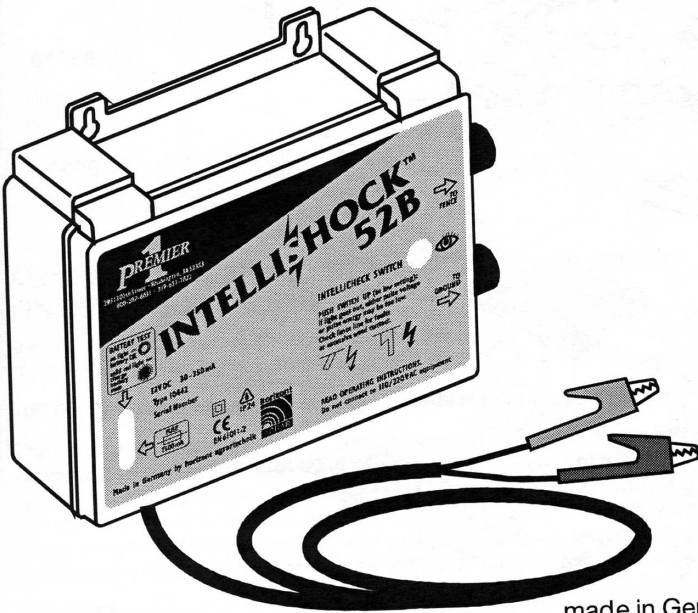

made in Germany
by **horizont agrartechnik gmbh**

1 PREMIER

2031 300th Street · Washington, IA 52353
www.premier1supplies.com
800-282-6631 · 319-653-7622

INTELLISHOCK™ 52B

Type 10442 12V DC

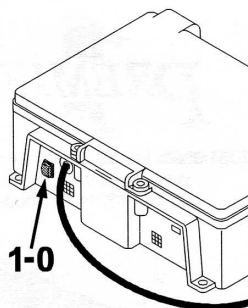
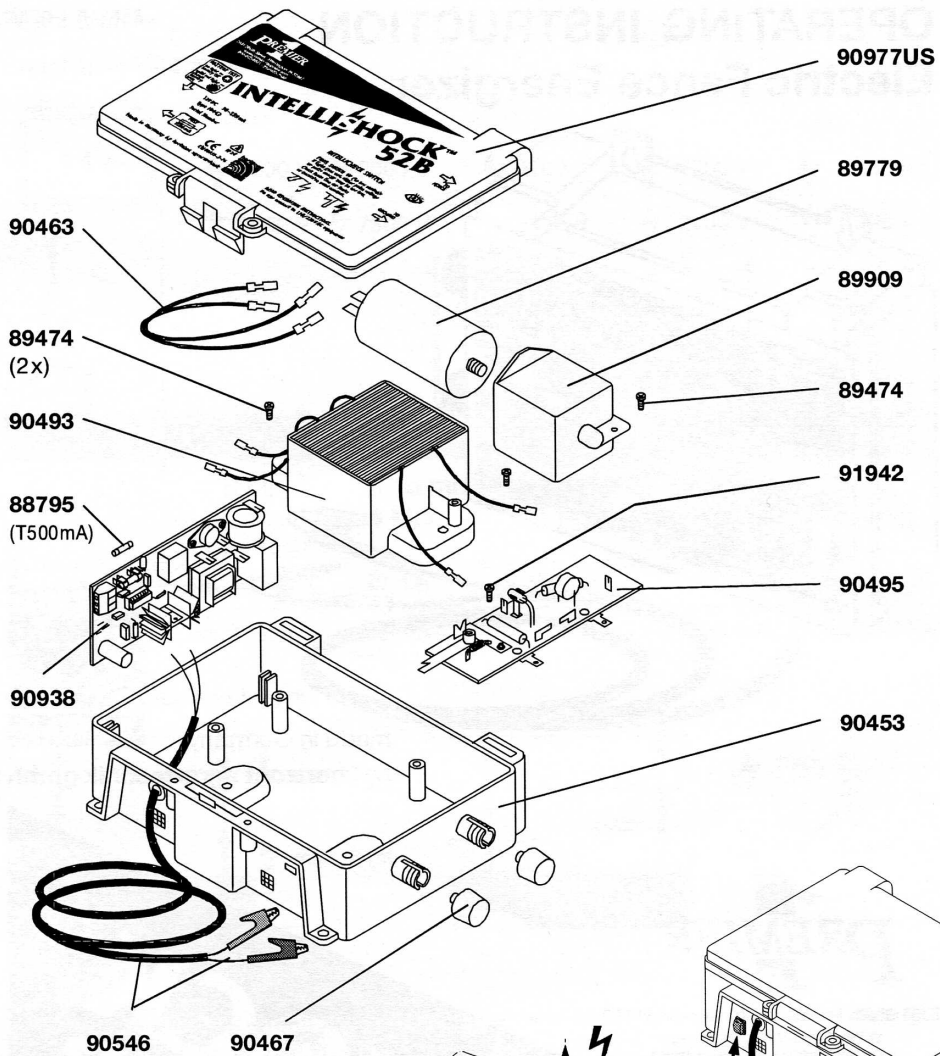

Energizer/Battery Carry Box:

A strong, galvanized steel box can be supplied onto which the energizer can be permanently attached, and into which the battery can be slid. The box has a strong plastic handle. The result is a very portable one piece unit.

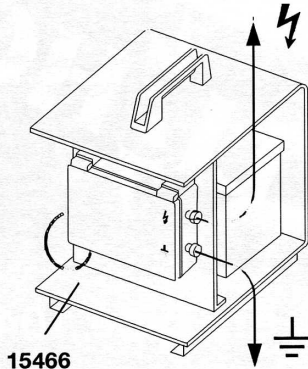

15466

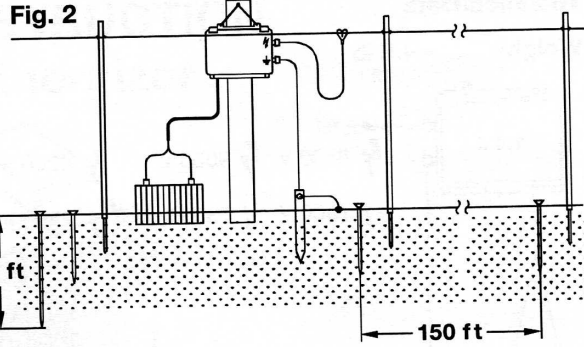
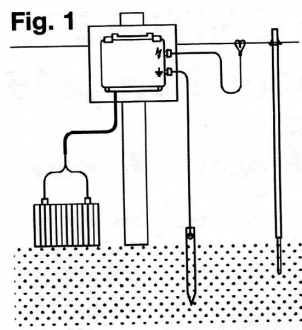

Operating instructions for electric fence controller "INTELLISHOCK™ 52B"

Installation and connection: The 52B energizer can be mounted either directly onto a wall or solid post (fig 1). It also can be hung from the attached cord (fig. 2).

IMPORTANT: The energizer must be mounted in an upright position !

The short ground stake must be driven into the ground as far as possible (preferably into moist soil) and connected to the ground terminal of the energizer by means of a non-corrosive wire. To ensure good grounding in all conditions, we advise using an additional ground rod of 3 ft. in length and driven into the soil 10 or more ft. from the first ground rod. Connect the two ground stakes to each other. Use the supplied fence connection wire to connect from the fence terminal to the fence (fig.1/fig. 2). If installed properly, the energizer can be left out in the weather, as it will shed water.

Operation and control: Connect the energizer to a 12v DC battery (preferably deep cycle). Ensure that the battery terminals are clean and that the polarity is correct (red to positive/ black to negative). Press button (1-0). If connected incorrectly, the energizer will not operate. If the red light under the left window flashes, the battery is not sufficiently charged.

If it does not flash, the battery charge is adequate. After a few seconds, a quiet ticking can be heard. The fence indicator light flashes with each pulse. There will be no flashing if the fence voltage drops below 2000 volts.

If it does not flash, disconnect the energizer from fence. If the fence indicator light does not flash when disconnected, the energizer is at fault and needs repair. If the fence indicator light flashes when disconnected the fence is at fault, either from too much vegetation contact or from a short between the wire and the ground or a metal post/wire attached to the ground. Correct as soon as possible.

INTELLICHECK SWITCH  The 42B energizer has two energy output settings (high and low). The settings are controlled by a brass switch. In the high setting (thick spark icon), the output is usually high enough to overcome moderate vegetation contact with the fence. However, in this setting, the fence indicator light is not voltage sensitive. To check the fence, push the switch up (into the energizer case) to the low, (thin spark icon) setting. This allows the energizer to properly, "look" at the fence and determine if the voltage is over 2000 volts.

If the switch is left in the up position, the energy output will be reduced. This setting is advised for weed-free horse fences and for short fences where strangers (especially children) might touch it.

Requirements: The energizer conforms to the standards indicated on the case (all European standards), which are more strict than USA UL standards.

Service: If the energizer fails, first check the fuse. If the fuse is OK, the fault will very likely be on the printed circuit board. This is supplied as a plug-in module. It can be replaced easily by your dealer or any local person with electronic training.

Subject to alterations !

Technical Data

Weight: ~ 4.5 lb

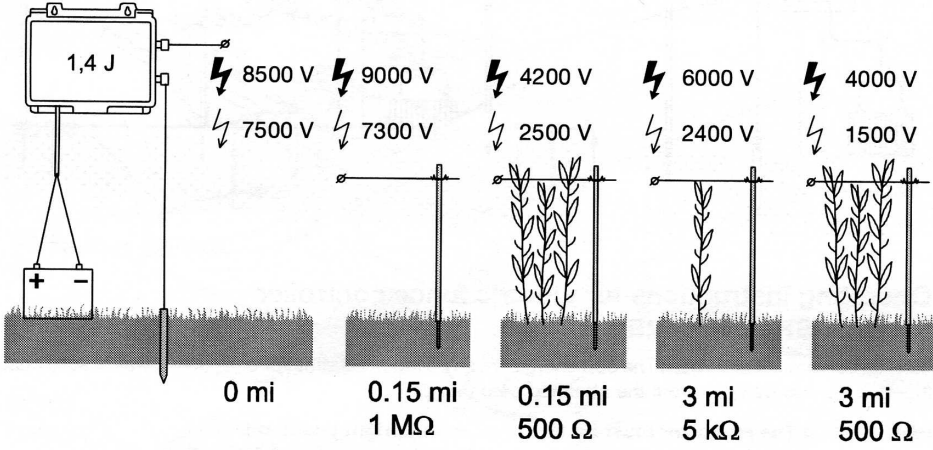

⚡	ca. 30 mA	ca. 30 mA	ca. 350 mA	ca. 300 mA	ca. 350 mA
⚡	ca. 30 mA	ca. 50 mA	ca. 350 mA	ca. 200 mA	ca. 250 mA

CEE: max. fence line length

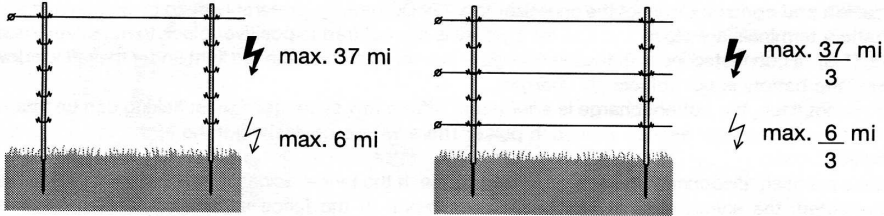

The energizer can be supplied as a solar unit.

A 10 watt 12 volt solar panel will be adequate if the fence line is usually clean of weeds, used in the summer only, or used in the southern part of the USA.

If the energizer is attached to a fence that is heavily laden with weeds in the northern part of the USA, a larger solar panel will be needed (but never larger than a 20 watt panel) to ensure that the battery remains charge all year long.

If you are not sure of which panel is best for you, call Premier's experts at 800 282 6631.

