

PrimaShock 4

INSTALLATION AND USER MANUAL



2031 300th St, Washington, IA 52353

800-282-6631

www.premier1supplies.com

All rights reserved

WARNING

Please read all instructions before using the energizer

DO NOT connect the fence to any other electric device.

- Lightning may strike your fence. A severe electric shock hazard exists to anything connected to the fence or in near proximity to the grounding system.
- If connecting the energizer to an AC power source, only use the provided AC adapter. The adapter should be covered adequately to protect it from rain, snow or other moisture. Keep out of reach of children.
- DO NOT charge the battery with a battery charger while the energizer is connected. Disconnect the energizer from the battery when re-charging is necessary.
- DO NOT connect more than one energizer to the fence at one time.
- DO NOT connect an energizer to barbed wire or razor wire.
- DO NOT install fence or grounding system within 30 feet of electrical power lines, telephone lines, telecommunications equipment or any other grounding source.
- If running leads underground use insulated wire rated for a minimum of 12,000 volts and then run the insulated wire through a conduit. Prevent water from entering conduit.
- Keep young children away from the electric fence at all times.
- DO NOT touch the fence with head, neck or torso.
- DO NOT climb over, through or under a multi-wire electric fence. Use a gate or disconnect the fence wires to cross.
- DO NOT put electric fence in areas of public access.
- Avoid constructing the fence adjacent to overhead power lines.
- Clearly mark the electric fence in several locations if located where people unfamiliar with the fence may come into its proximity. Check your local and state laws regarding placement of electric fences.
- Keep fence clear of obstructions or other objects that could potentially cause a person or animal to become entangled in the fence.
- DO NOT use a water pipe, well, or your main power system ground as the ground for your energizer. If lightning were to strike the fence, the current could travel through the system causing a severe electrical shock hazard.
- DO NOT place the grounding rod(s) in a location that could cause a person or animal to trip into the fence or be trapped between the ground wire and the fence.
- Always mount the energizer securely such that it will not fall if bumped by an animal or person.
- In times of extreme fire risk, disconnect the energizer.
- Keep combustible materials away from fence, energizer and battery.

Operator's Manual

This manual is designed to ensure you achieve optimum results from your energizer. To ensure maximum output with minimum complications and optimum safety, we advise you to follow the guidelines carefully concerning the correct installation of your fence energizer and the required ground system. Anything less will substantially affect the performance of the energizer and can result in unnecessary complications and installation expense.

About the electric fence energizer

This energizer is a comprehensive perimeter or strip fencing energizer and is an ideal solution for those who want a simple, efficient and cost-effective system to power their fences.

It is easy to install and can be operated using either 110v AC mains power, 12 volt (v) deep cycle lead-acid/gel battery or in conjunction with a 30/40/50 or other watt (w) solar panel, making this a suitable system for larger scale settings where no mains power is available. As a combination, fixed or portable system, the energizer provides flexibility with pasture management and is the ideal solution for short or long-term animal control or rotational crop grazing

How does an electric fencing system work?

An electric current, generated from an energizer which is grounded, travels along a fence wire as a pulse. The circuit between the fence and the ground is completed when an animal touches the fence wire and consequently receives a short, sharp but safe shock. This provides enough of a deterrent to an animal, making the electric fence a psychological barrier rather than a physical one.

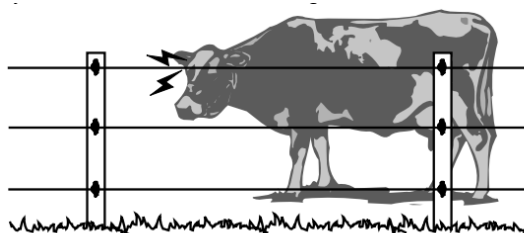

Fig 2.1
Page 3

Main features:

- ✓ Powered by: AC mains power or, 12v deep cycle lead-acid/gel battery (not included) or with a 30-60w solar panel (not included) in conjunction with a 12v battery as above
- ✓ 6 operating modes including a cost-efficient day/night full/half power save
- ✓ 2 different pulse intervals of 1.2 seconds and 2 seconds.
- ✓ 2 different max output of full and half energy
- ✓ LCD shows the energizer operation mode, voltage, interval time, setting etc.
- ✓ LED display the energizer power and status
- ✓ Waterproof and dustproof

Performance Characteristics

- ✓ Output voltage: 7-11 kv
- ✓ Pulse width: 100 us (1 / 10000 second)
- ✓ Stored joules: 6.4
- ✓ Released joules: 4.3
- ✓ Battery Draw: 100-200 milliamps/hour
- ✓ AC Draw: 2.7 watts/hour

Package Contents

- ✓ 1 Electric Fence Energizer
- ✓ 1 AC 110v power adapter
- ✓ 1 set of 12v battery leads

Parts of the energizer

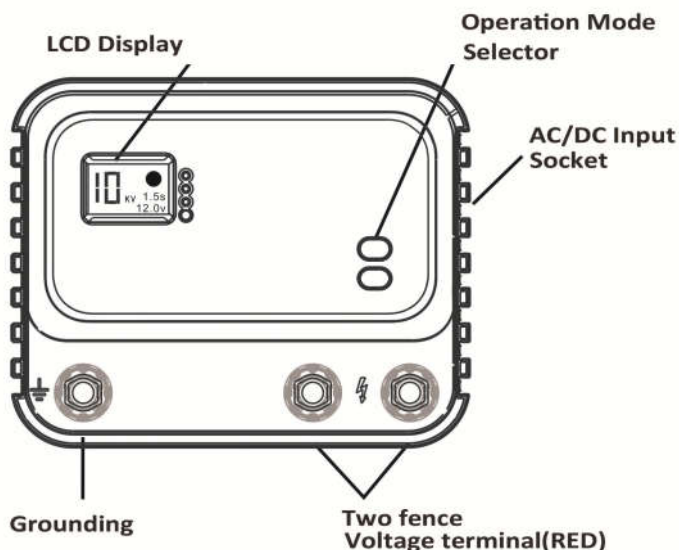

Energizer interface

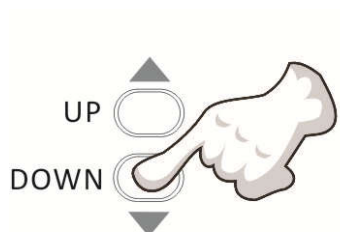

Operation buttons

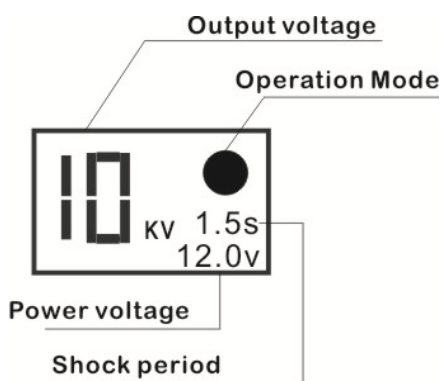

LED & LCD Indication

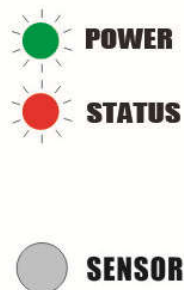

LED Indicators







Power – Should be green when properly connected to a 110v outlet or a fully charged 12v deep cycle battery.

Status – Should be red when the energizer is producing voltage.
If the Status light is not illuminated, then check the energizer.

Sensor – Light sensor for controlling pulse speed on Short Day/Long Night or Long Day/Short Night operational modes.

Operation Mode

The Operation Mode can be controlled by the Up/Down selector buttons.

<p>On - Hold Mode:</p> 	<p>The Power LED indicator should be green. Digital display will show Output Voltage at 0kv and the Input Power Voltage. Status LED indicator should not be lit. When in the On-Hold mode, the energizer will not generate a pulse.</p>
<p>Full Energy Mode:</p> 	<p>Energizer pulse will be every 1.2 seconds. The Power LED indicator should be green. Status LED indicator should be red. Digital display will show Output Voltage at the energizer as well as the Input Power Voltage.</p>
<p>Reduced Energy Mode:</p> 	<p>Energizer power is reduced by 25%. The energizer pulse will be every 1.2 seconds. The Power LED indicator should be green. Status LED indicator should be red. Digital display will show Output Voltage at the energizer as well as the Input Power Voltage.</p>
<p>Short-day Long-night Mode:</p> 	<p>Daytime pulse will be every 1.2 seconds, night pulse will be every 2 seconds. The Power LED indicator should be green. Status LED indicator should be red. Digital display will show Output Voltage at the energizer as well as the Input Power Voltage.</p>
<p>Long-day Short-night Mode:</p> 	<p>Daytime pulse will be every 2 seconds, night pulse will be every 1.2 seconds. The Power LED indicator should be green. Status LED indicator should be red. Digital display will show Output Voltage at the energizer as well as the Input Power Voltage.</p>
<p>Battery Saving Mode:</p> 	<p>Energizer power is reduced by 25%. The energizer pulse will be every 2 seconds. The Power LED indicator should be green. Status LED indicator should be red. Digital display will show Output Voltage at the energizer as well as the Input Power Voltage.</p>

When this energizer is plugged into a standard 110v outlet power source, the Power Voltage display will read close to 12.6v. When the energizer is attached to a 12v deep cycle battery, the Power Voltage should read between 12.2 and 13.6 volts. If the voltage of the battery reads lower than 12.2 volts that indicates it is time to recharge the battery.

Installing the Energizer

The Energizer can operate using 110v AC mains power, a 12v deep cycle lead-acid/gel battery or solar and lead-acid/gel battery combination.

AC 110v Mains Power

1. Attach the 110v AC mains power adapter to the energizer (insertion point is on the backside of the energizer) and plug into an 110v AC mains power outlet. THE 110V AC ADAPTER NEEDS TO BE PROTECTED FROM RAINFALL.
2. DO NOT turn the energizer on until the fence system is fully constructed and ready to be used.

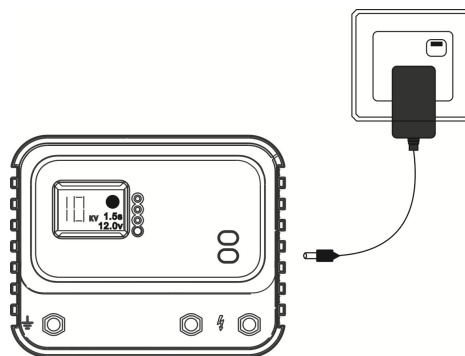

Notes:

- Mount out of reach of children and animals and placed off the ground to protect it from ground moisture and insects.
- Protect 110v power adaptor from weather.
- Leadout wire from the energizer to the fence should be at least a 14 gauge insulated wire and have an insulation value of at least 10,000 volts.
- Use at least 3' of galvanized ground rod per joule of energizer. Multiple rods should be placed at least 1.5 times the length of the rod apart from each other and connected with at least a 14 gauge galvanized ground wire.
- Place energizer ground system at least 30 feet away from any other electric or ground systems.

110v AC Installation

Mount the energizer on a wall, under cover, out of reach of children. Install where there is no risk of the energizer incurring fire, mechanical or water damage and if possible away from heavy electrical equipment, (e.g. pumps or other items that may cause electrical interference).

Note: Install the energizer in a frequently accessed place, the LCD output display gives valuable information that can save time and help prevent costly problems. Choose a mounting surface of sufficient strength, (e.g. stud or plywood panel) to be robust and of sufficient thickness to properly contain mounting screws (not supplied). On the mounting surface, mark where the screws for the top keyholes are to be attached. Ensure these are at the correct mounting height you require for the energizer and drill small pilot holes. Install screws leaving a 4mm gap between the head of the screw and the wall. Carefully hang the energizer over the screws.

Connecting the energizer to the fence

- Remove about 3 inches of insulation from both ends of the appropriate length of the insulated lead out wire with an insulation value of 10,000 volts or higher.
- Unscrew the RED knob on the energizer fence terminal. Insert one of the bare ends through the fence terminal of the energizer.
- Replace the RED knob and tighten
- Connect the other end of the insulated lead out wire to your fence.

Connecting the energizer to the ground system

- Remove about 3 inches of insulation from both ends of the appropriate length of the insulated lead out wire.
 - Unscrew the Black knob on the energizer ground terminal. Insert one of the bare ends through the ground terminal of the energizer.
 - Replace the Black knob and tighten
 - Connect the other end of the galvanized ground wire to your galvanized ground rod(s).
1. For normal ground systems use galvanized ground rods.
 2. An energizer will require 3 feet of ground rod per joule of energizer. This 4 joule energizer will require at least 12 feet of ground rods connected together. Use at least a 14 gauge ground wire to connect multiple ground rods together. Depending on the location and conditions of the ground system, additional stakes may be required.
 3. Space the ground rods at least 1.5 times apart as the length of the ground rod being used then drive them deeply into the soil leaving about 1-2 inches above the ground level to connect the ground rod(s) to the ground wire via ground rod clamps. Join the ground rods together in a continuous series using clamps and 14g or larger connecting cable. Galvanized connecting wire should be used with galvanized ground rods and stainless steel or galvanized connecting clamps.

Poor grounding is one of the most common reasons for poor electric fence performance.

It is very important to have a high quality ground system. Electrons travelling from the energizer must complete a circuit in order to give the animal an electric shock. From the energizer, electrons travel along the insulated fence wires, through the animal's body, through the soil to the grounding system – a number of connected ground rods collect the electrons in the soil - then return them to the energizer. If an electric fence is not grounded correctly, it will be much less effective.

Known factors	What happens?	What's the solution?
Dry, sandy pumice soil types	Allows electrons to disperse rather than be absorbed completely by ground rods. Reduces fence effectiveness.	<ul style="list-style-type: none"> • Use 3' of galvanized ground rod per joule of energizer. (i.e. a 1 joule energizer needs 3' of ground rod.) • If possible, choose a better (moister) location for placing the ground system. • Consider additional or deeper ground rods. • Adding moisture around the ground system may improve soil conductivity. • Consider installing a Pos/Neg fence system.
Weeds/vegetation touching energized fence wires	Electrons leak causing fence circuit to, "short" and voltage to drop. A properly electrified fence should measure at least 3000 volts at the end of the fence.	<ul style="list-style-type: none"> • Check entire fence lines regularly • Weed/grass management to ensure nothing touches the fence wires. • Trim back over-hanging tree branches which may also touch the fence wires.
Rusty or corroded ground rods	Do not conduct electrons	<ul style="list-style-type: none"> • Use clean, galvanized ground rods. Three feet of galvanized ground rod per joule of energizer. (ie a 1 joule energizer needs 3' of ground rod.)
Radio, TV or Phone Interference	Interference.	<ul style="list-style-type: none"> • Ensure the energizer ground system is at least 30 feet from any other grounding source.
Steel buildings, metal well pipes or LP tank systems.	Interference	<ul style="list-style-type: none"> • Do not connect grounding system to metal buildings, well pipes, metal water pipes or the ground system of LP tanks.
Machinery or livestock	Can damage components of the ground system	<ul style="list-style-type: none"> • Position ground system away from livestock or other traffic thoroughfares.
Mixed metals within the ground system	Electrolysis, causing some components of the ground system to corrode.	<ul style="list-style-type: none"> • Do not mix metals of differing conductivity e.g. never use copper wire directly onto galvanized ground rods.

Location of the ground system

The following examples are to help you with a suitable location for your ground system given a variety of conditions:

1. Normal system (All fence wires energized): Recommended where the soil is highly conductive, e.g. most moist soils.

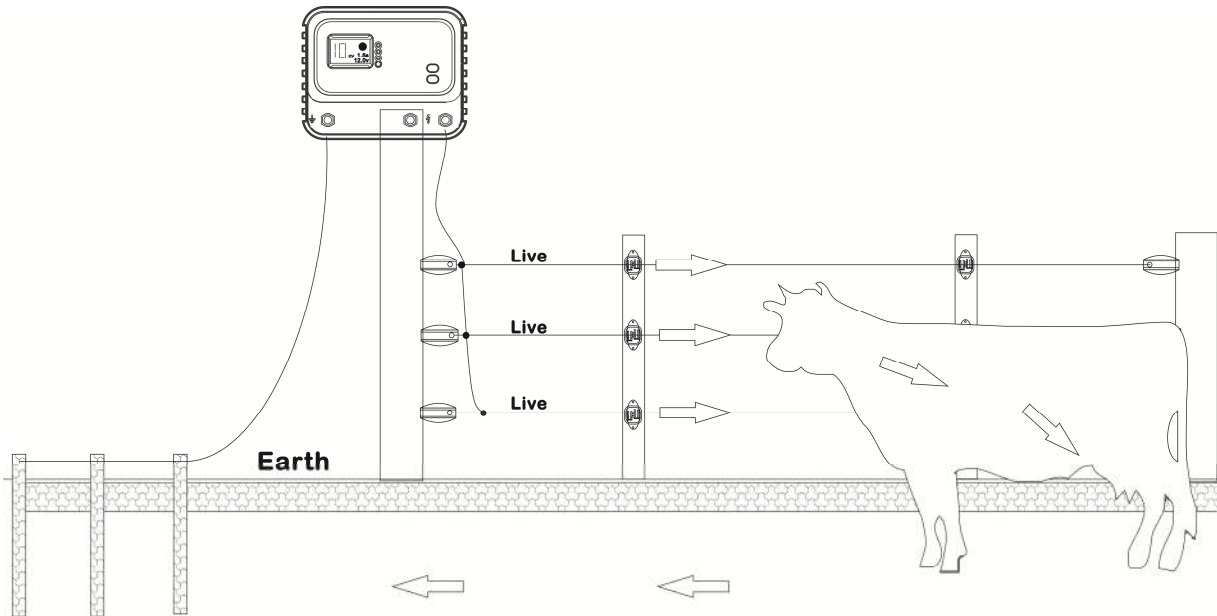

2. Pos./Neg. system: Where soils are not conductive e.g. dry, sandy, pumice soils as well as frozen soils or snow conditions, where an earth-return wire should be used in conjunction with the ground system – as per diagram. When the animal touches both a positive and a grounded wire, the animal will receive a shock.

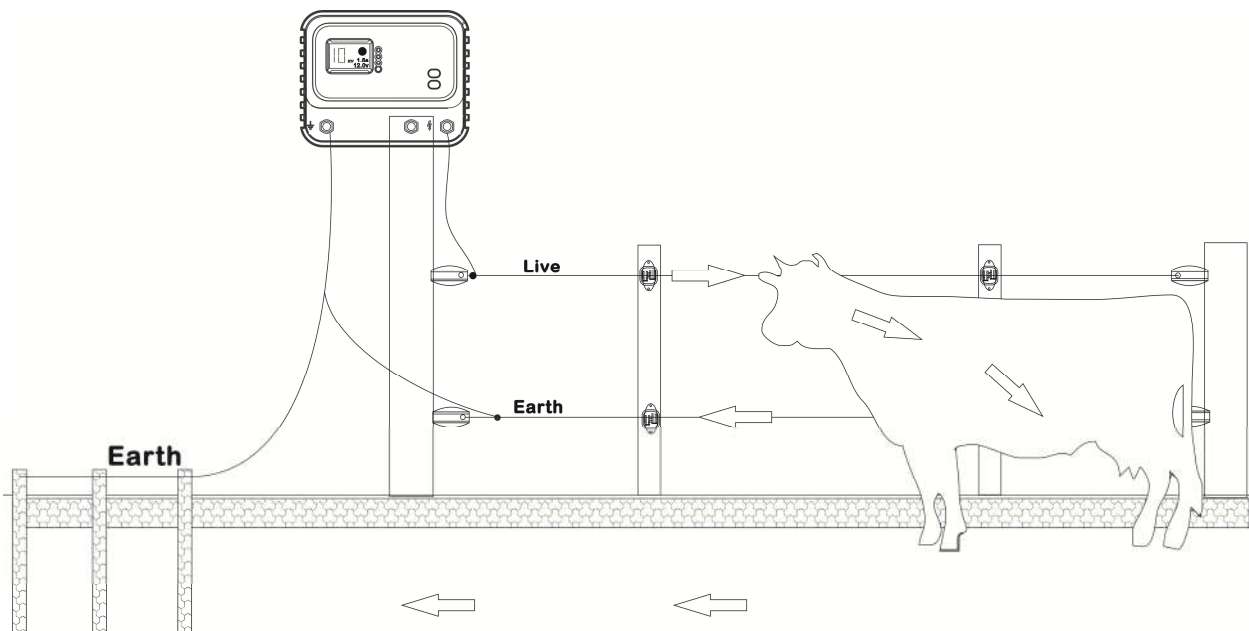

Final Step – Test voltage level at the end of the fence line with an electric fence tester. Voltage measurement should be at least 3000 volts.

DC Battery Power (battery not included)

1. Always use a 12 v deep cycle lead-acid/gel battery
2. Place the battery in a well-ventilated area
3. Attach the 12v battery leads to the Energizer – insertion point on the back side of the energizer.
4. Connect the RED clip to the POSITIVE (+) terminal of the 12v battery.
5. Connect the BLACK clip to the NEGATIVE (-) terminal of the 12v battery.

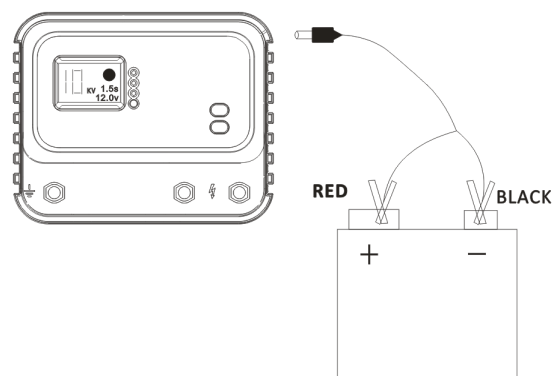

Notes:

- Mount out of reach of children & animals
- Use included wiring harness to connect the energizer to the fence and initial ground rod.
- Use at least 3' of galvanized ground rod per joule of energizer. Multiple rods should be placed at least 1.5 times the length of the rod apart from each other and connected with at least a 14 gauge galvanized ground wire.
- Energizer should be placed off the ground to protect it from ground moisture and insects.
- The battery should be recharged prior to the battery reaching 60% discharged.
- Use a 12v deep cycle marine type of battery 80 amps or larger.
- When using a rechargeable battery, choose one that withstands regular, charge and discharge cycles without damage, such as a marine or deep cycle type. Do not use an automotive battery because they supply high current for short periods and they will not sustain the repeated charges and discharges required.

Connecting the energizer to the fence using the wiring harness

This energizer is supplied with a wiring harness. For connecting to the fence -

- Unscrew the RED knob on the energizer fence terminal.
- Insert the bare end of the fence cable (with the Orange alligator clamp) through the hole of the energizer fence terminal.
- Replace the RED knob and tighten to secure the wire in place.
- Connect the Orange alligator clip to the fence.

Connecting the energizer to the ground system using the wiring harness

This energizer is supplied with a wiring harness. For connecting to the ground rod (s) -
(This energizer needs 12 feet of grounding rod.)

1. Unscrew the BLACK cap on the ground terminal of the energizer.
2. Insert the bare end of the grounding cable (with the Black alligator clamp) through the hole of the energizer ground terminal.
3. Replace the BLACK cap, tighten to secure the wire in place
4. Attach the Black alligator clip to the initial ground rod.
5. Install more ground rods as needed connecting them together with at least a 14 gauge wire.

Final Step – Test voltage level at the end of the fence line with an electric fence tester. Voltage measurement should be at least 3000 volts.

Solar/battery (panel & battery not included)

1. The energizer is compatible with a minimum 30 w solar fence panel and a 12 v deep cycle lead-acid/gel battery
2. Set up the solar panel as per the instructions using it with the appropriate regulator.
3. Attach the solar panel/regulator positive (+) lead to the positive (+) terminal of the battery.
4. Attach the solar panel/regulator negative (-) lead to the negative (-) terminal of the battery.
5. Attach the energizer 12v leads to the battery as instructed above under DC Battery Power.

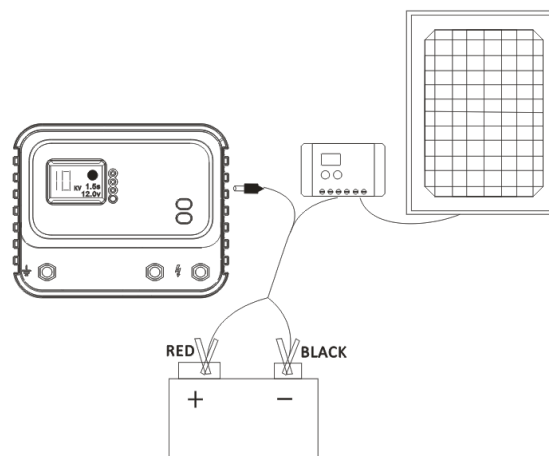

Note:

- Each battery terminal should now have two attachments – one each from the solar panel/regulator and the energizer.
- Use a 12v deep cycle marine type of battery 80 amps or larger plus a 30-50 watt solar panel and regulator (depend on the sunlight intensity).
- Mount out of reach of children & animals
- Use included wiring harness to connect the energizer to the fence and initial ground rod.
- Use at least 3' of galvanized ground rod per joule of energizer. Multiple rods should be placed at least 1.5 times the length of the rod apart from each other and connected with at least a 14 gauge galvanized ground wire.
- Energizer should be placed off the ground to protect it from ground moisture and insects.
- Solar panel should be connected to battery as directed previously
- Position the solar panel to face south. Panel should be nearly parallel with the ground during the summer, angled at 45 degrees for the spring and fall and nearly perpendicular to the ground during the winter to accommodate for the sun's changing angles.
- When using a rechargeable battery, choose one that withstands regular, charge and discharge cycles without damage, such as a marine or deep cycle type. Do not use an automotive battery because they supply high current for short periods and they will not sustain the repeated charges and discharges required.

Final Step – Test voltage level at the end of the fence line with an electric fence tester. Voltage measurement should be at least 3000 volts.

Testing /Troubleshooting

A fence tester, is an essential piece of equipment required to monitor the electrical output along the fence line, perform regular maintenance checks along the fence-lines as well as assisting to find faults quickly and easily, should they occur. If your fence-line is registering less than the recommended 3000v on your fence tester then check the following:

Possible cause	Action
Energizer	<ul style="list-style-type: none"> • If you require the energizer to power up greater distances, you will need to try a more powerful energizer. Additional fence requirements will require a second unit. • Check the power supply: Mains power - check the system is plugged in and switched on -ensure all leads/cables are properly connected Battery - check battery life and amount of stored energy -revert to mains power if battery level is below 10.8 v Solar/Battery - check battery life and amount of stored energy -change to back-up battery if battery level is low or 110v power if possible or charge the battery on the 110v recharger.
Ground System	<ul style="list-style-type: none"> • Ensure there are a minimum of 3ft of ground rod per joule of energizer, more if soil conditions warrant it • If multiple ground rods are needed, check that ground stakes are spaced at least 6ft apart and buried deeply in the soil • Check that all connections to the ground stakes are secure • It is vital that all components of the ground system are made of the same metal • Ensure the position for the ground system is located in a damp location • If there is a severe dry period, you may need to water the ground system or consider repositioning your ground system.
Lead-out cable/wire	<ul style="list-style-type: none"> • Check the connection to the energizer is secure • If using a longer length lead-out cable/wire to the one supplied, ensure a large diameter, well insulated, high voltage cable/wire. Do not use household electrical cable, copper wire or barbed wire • Ensure the wire is sufficiently insulated, particularly if sited underground • Check there are no stray wires and no vegetation touching the lead-out wire • Check all cable joins to ensure connections are insulated and secure
Fence line	<ul style="list-style-type: none"> • Walk the entire fence using a fence tester along the line, checking about every 300 ft. If the short is serious the voltage will continue to drop until the fault is reached • Check all joints in the wire to ensure they are secure • Check the fence wire itself for any signs of corrosion • Vegetation touching the fence line is the greatest cause of voltage loss. Maintain

	<p>fencelines, ensuring weeds, low hanging branches and other vegetation growth is kept away from the fence lines. Ensure the wire position and tension is adequate to keep the lines above any vegetative growth</p>
<p>Radio interference</p>	<ul style="list-style-type: none"> • Ensure the ground system is highly conductive • Install the energizer away from any other grounding system • Make certain the energizer ground wire does not touch a building or anything which could act as an aerial • Keep all radios and similar equipment away from the energizer • Ensure the 110v power supply is properly grounded and all components are in good condition • Keep vegetation away from the energizer itself
<p>Interference can be detected by either: a) Clicking noises on the telephone line b) Slow or variable internet connection</p>	<ul style="list-style-type: none"> • DO NOT run the lead-out cable/wire or the fence wires, for any distance in parallel with telecommunications wires • Lead-out cable/wire and fence wire must be sited at least 300ft away from telecommunications lines • Ensure the ground system is sited at least 30ft from telecommunications lines and other ground systems • Check all wires and connections along the entire perimeter of the powered fence system and ensure they are in good condition • If the fault persists, find an alternate route for the lead-out cable/wire and fence wire so that it runs away from the telecommunications lines rather than alongside them

Testing the ground system

Ideally, you should perform this test at least ONCE each year and also during any dry season. This ensures the grounding capacity is sufficient to meet the demands of the energizer.

To perform the test you will need:

Several steel rods or lengths of pipe & a digital fence tester.

1. Turn OFF the energizer.
2. Using several steel rods or lengths of pipe, short circuit the fence by laying these against the fence at least 300 ft away from the energizer. In dry or sandy soil conditions, drive the rods up to 12 inches into the soil.
3. Turn ON the energizer and measure the fence voltage using the digital fence tester. The reading should be 2kv or less. If not, put more steel rods against the fence.
4. Now, check the ground system by fully inserting the earth probe of the fence tester into the surrounding soil and attach the fence tester clip to the last energizer ground stake. The reading should be no more than 0.2 kV. If the reading is higher, the ground system is insufficient and you should add more ground rods.

Maintenance

For a safe reliable electric fencing system, we recommend you follow these helpful tips:

- Regularly wipe down the unit with a soft damp cloth to ensure that there is no build-up of mold etc.
- Do not use any abrasives which may damage the coating of the energizer
- Clean any connections and terminals which may be showing signs of corrosion
- Perform a thorough test of the ground system at least ONCE each year and also during any dry season
- Inspect fence lines regularly, clearing any weeds, low hanging branches or other vegetation in direct contact with the wire
- Check fence wire positions and tensions to ensure they are adequate to keep the fence lines above vegetative growth
- Ensure all fence wire insulators are intact and in good condition