

USER MANUAL

6, 12 J Unigizer™

WARNING: READ ALL INSTRUCTIONS

ENGLISH.....	1
ESPAÑOL.....	13
PORTUGUÊS.....	25
FRANÇAIS.....	37
DEUTSCH.....	50
SVENSKA.....	62
NEDERLANDS.....	73
DANSK.....	85
WARRANTY.....	98
TEMPLATES.....	99

© 2008-2010 Tru-Test Limited

All product names and brand names in this document are trademarks or registered trademarks of their respective holders.

No part of this publication may be photocopied, reproduced, stored in a retrieval system, or transmitted in any form or by any means, electronic, mechanical, photocopying, recording or otherwise without the prior written permission of Tru-Test Limited. Product specifications may change without prior notice.

For more information on other quality Tru-Test Group brands and products, visit www.tru-test.com.

Tru-Test Limited
25 Carbine Road
Mt Wellington
Auckland 1060
New Zealand

Postal address:
P O Box 51078
Pakuranga
Manukau 2140
New Zealand

Tru-Test Ltd thanks the International Electrotechnical Commission (IEC) for permission to reproduce information from its International Publication 60335-2-76 ed.2.1 (2006). All such extracts are copyright of IEC, Geneva, Switzerland. All rights reserved. Further information on the IEC is available from www.iec.ch. IEC has no responsibility for the placement and context in which the extracts and contents are reproduced by the author, nor is IEC in any way responsible for the other content or accuracy therein.

816260 Issue 1 10/2010

ENGLISH

Electric fencing and your energizer

Congratulations on the purchase of your energizer. This product has been constructed using the latest technology and construction techniques. It has been engineered to give superior performance and many years of service.

It is important to read these instructions carefully and thoroughly. They contain important safety information and will assist you in ensuring that your electric fencing system gives maximum performance and reliability.

How does an electric fence work?

An electric fence system comprises an energizer and an insulated fence. The energizer puts very short pulses of electricity onto the fence line. These pulses have a high voltage, but are of very short duration (less than 3/10,000ths of a second). However, a shock from an electric fence pulse is very uncomfortable and animals quickly learn to respect electric fences. An electric fence is not only a physical barrier, but is also a strong psychological barrier.

What are the benefits of an electric fence?

An electric fence has many benefits over conventional fencing:

- Requires less labour and materials to construct.
- Flexibility to change or add paddocks when required. The use of strip grazing techniques can allow temporary fencing to be quickly and easily erected or removed.
- Controls a broader range of animals.
- Minimises damage to expensive livestock when compared with other fencing mechanisms, for example barbed wire.





Models covered by this manual

This manual covers various energizer models:

12000i, X12i, 412i	12 J unigizers. These energizers have an LCD display, an earth monitoring feature and remote control capabilities.
12000i-EU, X12i-EU, 412i-EU	12 J unigizers sold in Europe. These energizers have an LCD display, an earth monitoring feature and remote control capabilities. If the energizer detects a sudden increase in the load on the fence, a warning is issued. The energizer may increase its output power to more effectively energise the fence.
6000i, X6i, 406i	6 J unigizers. These energizers have an LCD display, an earth monitoring feature and remote control capabilities.
6000i-EU, X6i-EU, 406i-EU	6 J unigizers sold in Europe. These energizers have an LCD display, an earth monitoring feature and remote control capabilities. If the energizer detects a sudden increase in the load on the fence, a warning is issued. The energizer may increase its output power to more effectively energise the fence.
6000, X6, 406	6 J unigizers.
6000-EU, X6-EU, 406-EU	6 J unigizers sold in Europe. If the energizer detects a sudden increase in the load on the fence, a warning is issued. The energizer may increase its output power to more effectively energise the fence.

Note: The energizers listed here may not be available in all markets.

Key to symbols on the energizer

-  Fence earth terminal. Connect the fence earth terminal to the energizer earth system.
-  Fence earth monitor terminal (*12000i, 12000i-EU, X12i, X12i-EU, 412i, 412i-EU, 6000i, 6000i-EU, X6i, X6i-EU, 406i and 406i-EU energizers only*). Connect the fence earth monitor terminal to a separate earth rod. See *Earth monitoring* on page 5.
-  Fence half voltage terminal. For use in areas with poor earthing, see *Bi-polar installation* on page 8 or in areas where a limit of 5 kV fence voltage is desirable (e.g. where fire risk is present or where there is a risk of someone touching the fence), see *Reducing the fence voltage output* on page 8. Connect the fence half voltage terminal to the fence.
-  Fence full voltage terminal. Connect the fence full voltage terminal to the fence.



Risk of electric shock! This energizer should be opened or repaired only by qualified personnel.



Read full instructions before use.



This symbol on the product or its packaging indicates that this product must not be disposed of with other waste. Instead, it is your responsibility to dispose of your waste equipment by handing it over to a designated collection point for the recycling of waste electrical and electronic equipment. The separate collection and recycling of your waste equipment at the time of disposal will help conserve natural resources and ensure that it is recycled in a manner that protects human health and the environment. For more information about where you can drop off your waste equipment for recycling, please contact your local city recycling office or the dealer from whom you purchased the product.



The energizer has a double-insulated construction.



12000i-EU, X12i-EU, 412i-EU, 6000i-EU, X6i-EU, 406i-EU, 6000-EU, X6-EU and 406-EU energizers only

Energizers marked with this symbol are time delayed electric fence energizers with a delay time of 50 seconds. See *Fence voltage* on page 5.

Warning!

- USA and Canada - To reduce the risk of electric shock, the energizer's power adaptor may have a polarized plug (one blade is wider than the other). This plug will fit in a polarized outlet one way. If the plug does not fit fully in the outlet, reverse the plug. If it still does not fit, contact a qualified electrician to install the proper outlet. Do not change the plug in any way.
- Switch the energizer off before installation or performing any work on the fence.
- Read all the safety considerations carefully. See *Safety considerations* on page 10.
- Check your installation to ensure that it complies with all local safety regulations.
- Do not connect simultaneously to a fence and to any other device such as a cattle trainer or a poultry trainer. Otherwise, lightning striking your fence will be conducted to all other devices.
- Use only the mains/line power adaptor or battery leads supplied with this energizer or a genuine replacement part.

Notes:

- This product has been designed for use with electric animal fences.
- Keep these instructions in a handy location.

Parts of the energizer

6000, 6000-EU, X6, X6-EU, 406, 406-EU

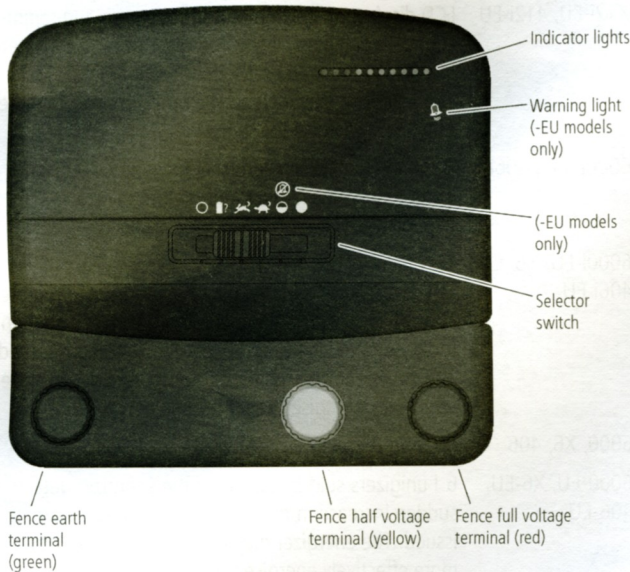

12000i, 12000i-EU, X12i, X12i-EU, 412i, 412i-EU, 6000i, 6000i-EU, X6i, X6i-EU, 406i, 406i-EU

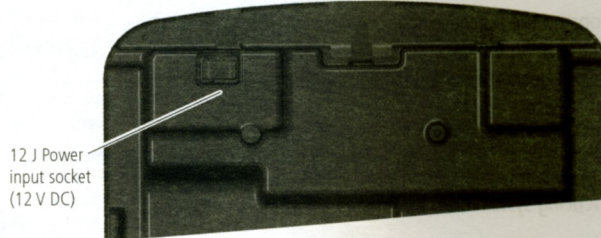
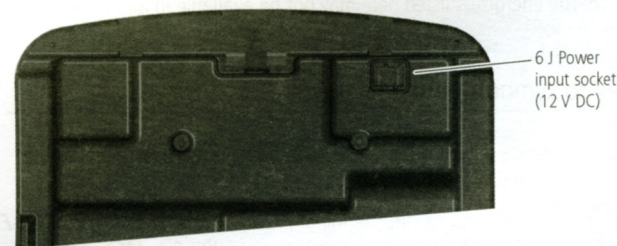
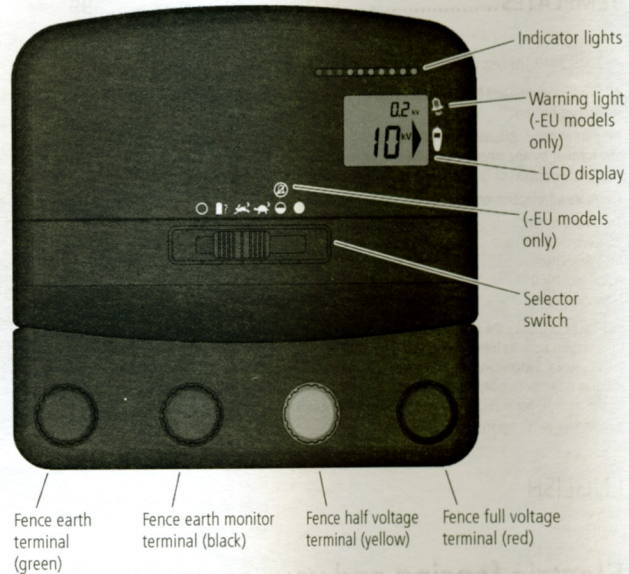

Installation

Read all of the safety instructions in this manual and any relevant government, regional and local safety standards before installing the energizer.

Selecting a site for the installation

Follow these guidelines when selecting a site for your installation.

Select a site where:

- a good earth can be obtained
 - the energizer earth system will be at least 10 m (33') from other earth systems (e.g. telephone, mains power or the earth system of another energizer)
 - children and animals cannot interfere with the installation
- Make sure the energizer is installed:

- adjacent to the electric fence
- preferably in the middle of the electric fence system
- close to a mains/line power outlet (if using a mains/line supply to power the energizer)
- at least 1 m (3') away from and not directly above the battery (if using a battery to power the energizer)

If your installation is outdoors, also make sure that it is:

- on firm ground away from flooding
- inside a protective fence, if required.

Using the power adaptor and battery leads

The energizer is supplied with a power adaptor (for connection to mains/line power) and a set of battery leads (for connection to a battery). Before connecting a power adaptor or battery leads, ensure the energizer's selector switch is set to Off .

To use the power adaptor:

- 1 Connect the power adaptor to the Power input socket on the rear of the energizer.
- 2 Connect the power adaptor to a suitable mains/line power socket, ensuring there is 25 mm (1") of clear space around the power adaptor.

To remove the power adaptor:

- 1 Disconnect the power adaptor from the mains/line power.
- 2 Pull on the white connector to remove the power adaptor plug from the Power input socket on the rear of the energizer.

To use the battery leads:

- 1 Insert the battery lead into the Power input socket on the rear of the energizer.
- 2 Connect the energizer to the battery using the battery leads supplied. Attach the red clip to the positive (+) terminal of the battery, and the black clip to its negative (-) terminal.

Note: If the energizer is to be used as part of a permanent outdoor installation such as a solar installation, the battery lead clips should be replaced by permanent battery connectors.

To remove the battery leads:

- 1 Remove the clips from the battery terminals.
- 2 Hold the battery lead by the rubber sleeve at the end of the wire. Pull firmly to remove the connector from the Power input socket on the rear of the energizer.

Installing the energizer indoors

The energizer must be installed indoors, (under cover) when being powered by mains/line power.

Warning!

- Do not use a mains/line power extension lead.
- Allow 25 mm (1") of clear space around the power adaptor.

To install the energizer indoors:

- 1 Select a suitable installation site. See *Selecting a site for the installation* on page 3.
- 2 Mount the energizer on a wall 1.7 m (5'6") above ground level. Use the template printed on the back cover of this manual, if required.
- 3 Connect the Fence earth terminal (green) to the energizer earth system.
- 4 *12000i, 12000i-EU, X12i, X12i-EU, 412i, 412i-EU, 6000i, 6000i-EU, X6i, X6i-EU, 406i and 406i-EU energizers only:* If earth monitoring is desired, connect the Fence earth monitor terminal (black) to a separate earth rod. For more information, see *Earth monitoring* on page 5.
- 5 Connect the Fence full voltage terminal (red) or the Fence half voltage terminal (yellow) to the fence.
- 6 Connect the energizer to mains/line power using the mains/line power adaptor provided. See *Using the power adaptor and battery leads* on page 3.

Note: For information about using the Fence half voltage terminal for a bi-polar fence installation, see *Bi-polar installation* on page 8. For information about using the Fence half voltage terminal to reduce the fence voltage output, see *Reducing the fence voltage output* on page 8.

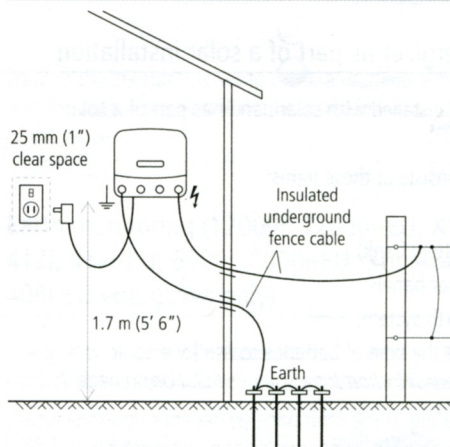

Note: If the energizer is being installed indoors, it may be powered by a battery instead of mains/line power, if required.

Warning! If using a battery to power an energizer that is installed indoors, ensure that there is adequate ventilation to allow battery gases to disperse.

Installing the energizer outdoors

The energizer may be installed outdoors, powered by a battery.

Warning! USA/Canada - Refer to *Important safety instructions for Class 2 power units (USA/Canada only)* on page 11. All other countries - Do not power the energizer with mains/line power if it is being installed outdoors.

To install the energizer outdoors:

- 1 Select a suitable installation site. See *Selecting a site for the installation* on page 3.
- 2 Mount the energizer on a post. Use the template printed on the back cover of this manual, if required.
- 3 Connect the Fence earth terminal (green) to the energizer earth system.
- 4 *12000i; 12000i-EU, X12i, X12i-EU, 412i, 412i-EU, 6000i, 6000i-EU, X6i, X6i-EU, 406i and 406i-EU energizers only:* If earth monitoring is desired, connect the Fence earth monitor terminal (black) to a separate earth rod. For more information, see *Earth monitoring* on page 5.
- 5 Connect the Fence full voltage terminal (red) or the Fence half voltage terminal (yellow) to the fence.
- 6 Connect the energizer to the battery using the battery leads provided. See *Using the power adaptor and battery leads* on page 3.

Note: For information about using the Fence half voltage terminal for a bi-polar fence installation, see *Bi-polar installation* on page 8. For information about using the Fence half voltage terminal to reduce the fence voltage output, see *Reducing the fence voltage output* on page 8.

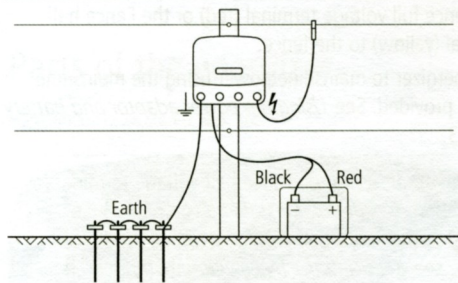

Installing the energizer as part of a solar installation

The energizer may be installed with solar panels as part of a solar installation.

A solar installation consists of these items:

- The energizer
- A battery (or battery bank)
- One or more solar panels
- An energizer earth system.

For information about the type of batteries to use for a solar installation, see *Battery selection for a solar installation* on page 7.

The required power rating of the solar panel(s) depends upon the local conditions. For help with positioning your solar panel correctly, see the supplier of your solar panel and refer to your local meteorological service. For more information about solar installations, refer to www.tru-test.com.

Warning! Do not power the energizer with mains/line power if it is being installed outdoors. USA/Canada - Refer to *Important safety instructions for Class 2 power units (USA/Canada only)* on page 11.

To install the energizer as part of a solar installation:

- 1 Select a suitable installation site. See *Selecting a site for the installation* on page 3. For solar installations, it is also important to select a site where the solar panel(s) will not be subject to shading from the sun at any time.
- 2 Face the solar panel towards true north in the southern hemisphere and true south in the northern hemisphere.
- 3 Tilt the panel so that it faces directly on to the mid-winter midday sun. If necessary, to increase efficiency, adjust the tilt angle at different times of the year.

- 4 When the solar panel is positioned correctly, attach the energizer to the rear of the panel. Alternatively, mount the energizer on a fence post. Use the template printed on the back cover of this manual, if required.
- 5 Connect the Fence earth terminal (green) to the energizer earth system.
- 6 *12000i; 12000i-EU, X12i, X12i-EU, 412i, 412i-EU, 6000i, 6000i-EU, X6i, X6i-EU, 406i and 406i-EU energizers only:* If earth monitoring is desired, connect the Fence earth monitor terminal (black) to a separate earth rod. For more information, see *Earth monitoring* on page 5.
- 7 Connect the Fence full voltage terminal (red) or the Fence half voltage terminal (yellow) to the fence.
- 8 Connect the battery to the solar panel.
- 9 Connect the energizer to the battery using the battery leads provided, but replace the battery lead clips with permanent battery connectors. See *Using the power adaptor and battery leads* on page 3.

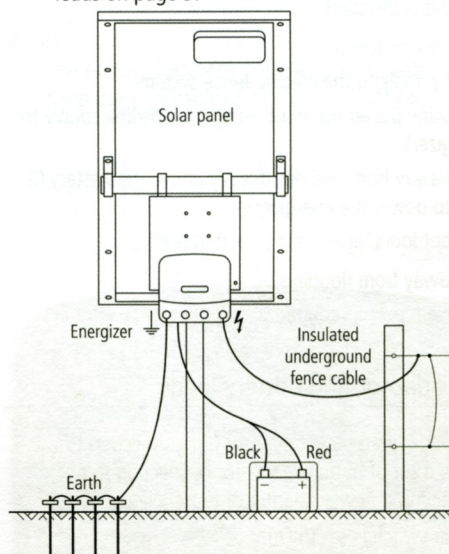

Operation

Select the appropriate pulse speed and output power level using the selector switch.

12000i; 12000i-EU, X12i, X12i-EU, 412i, 412i-EU, 6000i, 6000i-EU, X6i, X6i-EU, 406i and 406i-EU energizers only:

When the energizer is switched on, for the first few seconds the LCD display and the indicator lights show the firmware version and remote control address setting (only required for advanced troubleshooting and servicing). After this, the energizer resumes normal operation. In poor light conditions, when the selector switch position is changed, the LCD display illuminates for 20 seconds.

6000, 6000-EU, X6, X6-EU, 406 and 406-EU energizers only:

The energizer begins normal operation within 6 seconds of being switched on.

Using the selector switch

Setting	Description
○ Off	The energizer is off and is not operating. When the selector switch is in the Off position, the energizer will not respond to commands from a remote control.

Battery Test

The battery voltage is displayed by the indicator lights (all models) and on the LCD (12000i, 12000i-EU, X12i, X12i-EU, 412i, 412i-EU, 6000i, 6000i-EU, X6i, X6i-EU, 406i, 406i-EU energizers only). See *Testing the battery voltage* on page 6. When this setting is used, the energizer operates at slow speed (2.5 seconds between pulses).

Slow Speed - Day Fast Speed - Night

The energizer operates at slow speed (2.5 seconds between pulses) during the day and fast speed (1.5 seconds between pulses) at night. When this setting is used, the energizer operates at full power. This setting is for animals active during the night and is a useful way of conserving battery power when a battery is being used to power the energizer.

Fast Speed - Day Slow Speed - Night

The energizer operates at fast speed (1.5 seconds between pulses) during the day and slow speed (2.5 seconds between pulses) at night. When this setting is used, the energizer operates at full power. This setting is for animals active during the day and is a useful way of conserving battery power when a battery is being used to power the energizer.

Low Power (12000i, X12i, 412i, 6000i, X6i, 406i, 6000, X6 and 406 energizers only)

The energizer operates at half power and fast speed (1.5 seconds between pulses).

Low Power (warning alarm disabled) (12000i-EU, X12i-EU, 412i-EU, 6000i-EU, X6i-EU, 406i-EU, 6000-EU, X6-EU and 406-EU energizers only)

The energizer operates at half power and fast speed (1.5 seconds between pulses). When the selector switch is on this setting, the warning alarm will not activate.

Full Power

The energizer operates at full power and fast speed (1.5 seconds between pulses).

Fence voltage

The Indicator lights show the voltage at the energizer's Fence full voltage terminal. Each Indicator light segment represents an increment of approximately 1 kV (1000 V) of output voltage. For example, if the first eight Indicator light segments are illuminated at each pulse, the output voltage is approximately 8 kV (8000 V).

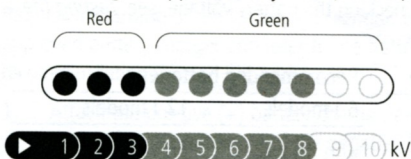

Note: If ten Indicator light segments are illuminated, the output voltage may be more than 10 kV (10,000 V).

If you see only red lights at each pulse and no green lights, your fence line is very heavily loaded, and you will need to look for faults on the fence line. See *Frequently asked questions/Troubleshooting* on page 11.

12000i, 12000i-EU, X12i, X12i-EU, 412i, 412i-EU, 6000i, 6000i-EU, X6i, X6i-EU, 406i and 406i-EU energizers only:

When the energizer is operating, the large digits on the LCD display show the output voltage at the energizer's Fence full voltage terminal.

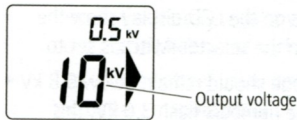

Note: If the large digits on the LCD display flash 1.0 kV, this indicates that the fence voltage is below 1000 V. There is a serious fault on the fence line. See "How do I locate faults?" in *Frequently asked questions/Troubleshooting* on page 11.

12000i-EU, X12i-EU, 412i-EU, 6000i-EU, X6i-EU, 406i-EU, 6000-EU, X6-EU and 406-EU energizers only:

If the energizer detects a sudden increase in the load on the fence, a warning light will flash (🔔), the pulse rate will reduce and a warning buzzer will sound for up to 10 minutes.

For example, this may occur:

- if a cutout switch is closed, connecting a heavily loaded section of the fence to the energizer
- if a branch falls on the fence
- if the fence or cable connecting energizer to it experiences a sudden short to ground
- if something becomes entangled in the fence.

50 seconds after the fence becomes heavily loaded, the energizer may increase its output power to more effectively energise the fence.

When a warning alarm is issued, switch the energizer off, locate and remedy fault then turn the energizer on again.

Note: If the energizer is set to (🔔), a warning alarm will not be issued and the output power will not be increased, regardless of the condition of the fence.

Earth monitoring (12000i, 12000i-EU, X12i, X12i-EU, 412i, 412i-EU, 6000i, 6000i-EU, X6i, X6i-EU, 406i and 406i-EU energizers only)



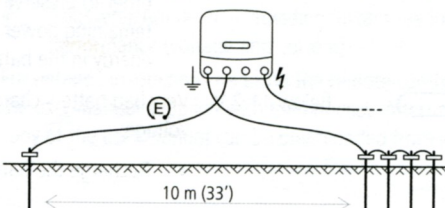

The quality of the earth affects the fence voltage. The earth monitoring feature allows you to keep an eye on the earth quality to make the most of your electric fence. A low voltage on the earth monitor indicates a good earth connection. A high voltage on the earth monitor indicates a poor earth connection.

Setting up for earth monitoring

The earth monitoring feature works by comparing the voltage of the energizer's earth system with that of a separate earth rod. Ensure the separate earth rod is at least 10 m (33') away from any other earth system including the energizer's main earth system. Locate the earth rod in the opposite direction to the lead out wire. Drive one 2 m (6'6") earth rod into the ground. Use high-voltage, insulated cable and an earth clamp to connect the earth rod and the energizer's Fence earth monitor terminal. Make sure the insulation is stripped back to ensure good contact between the wire and the earth rod.



Monitoring the earth

If the first Indicator light is illuminated permanently, this indicates that the earth voltage is over 0.8 kV and that better earthing may be beneficial. Either add more earth rods or find a better location for the energizer earth system. The small digits on the LCD display show the voltage going to the earth system when the selector switch is set to , ,  or . The earth voltage should remain below 0.8 kV at all times. If the earth monitor voltage numbers flash 3.0 kV, this indicates the earth voltage is above 3.0 kV. See *Installing and testing an earth system* on page 9 for information about installing an earth system effectively.

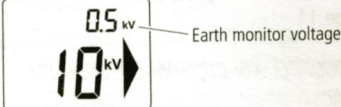





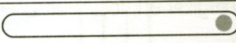

Testing the battery voltage

The energizer's Battery Test setting can be used to monitor the battery voltage.

When the selector switch is set to Battery Test , the Indicator lights show the input supply voltage. This can be useful in order to monitor the battery charge level.

Note: When the selector switch is set to Battery Test , the energizer pulses at slow speed (2.5 seconds between pulses) and the fence is live.

Lights	Input supply voltage	Battery-only installation
	Above 17.0 V	Abnormal conditions, check battery and connections.
	12.6 V-17.0 V	Full battery charge voltage (80-100%): <ul style="list-style-type: none"> No action required.
 or 	12.3-12.6 V or 12.0-12.3 V	Medium battery charge voltage (50-80%): <ul style="list-style-type: none"> No action required.
	11.7-12.0 V	Low battery charge voltage (20-50%): <ul style="list-style-type: none"> Monitor battery voltage. Recharge the battery to avoid long-term damage to the battery.
	11.2-11.7 V	Bad battery charge voltage (10-20%): <ul style="list-style-type: none"> Recharge the battery immediately. Energizer will automatically revert to Slow Speed and Low Output Power in order to preserve the remaining power and energy in the battery.
	Below 11.2 V	Very bad battery charge voltage: <ul style="list-style-type: none"> Recharge the battery

immediately

- The energizer will not function in order to preserve the battery.

Notes:



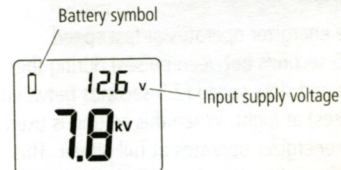

- In extreme temperatures, these guidelines may not apply.
- The battery test results will display for 30 seconds after the selector switch is set to Battery Test .

12000i, 12000i-EU, X12i, X12i-EU, 412i, 412i-EU, 6000i, 6000i-EU, X6i, X6i-EU, 406i and 406i-EU energizers only

When the selector switch is set to Battery Test , the LCD display also displays the input supply voltage.



When the voltage is outside the normal range (below 11.8 V or above 17 V), the battery symbol flashes.

During normal operation, when the selector switch is set to , ,  or , if the battery voltage is bad, the battery symbol on the LCD display flashes. Recharge the battery immediately.







Battery selection and management

This section refers exclusively to 12 V rechargeable batteries.

The batteries you select will depend on whether your installation is a solar or a battery-only installation. For both types of installation, the selector switch position you use most frequently will be a factor. Refer to *Operation* on page 4 for an explanation of the function of the selector switch.

Battery selection for a battery-only installation

As a guide, the amp hour (Ah) rating of the 12 V rechargeable batteries required is shown below. This table is based on a 21 day operating period between battery charging. Although operating time can exceed 21 days, this is likely to cause battery damage and will necessitate frequent replacement of the battery. For best system reliability and long term battery life, the preferred battery and charging regime is to use a 12 V rechargeable battery and to recharge it when it is half discharged. For more information on checking the battery voltage, see *Testing the battery voltage* on page 6.

Selector switch position	Recommended batteries	
	6 J models	12 J models
	450 Ah	700 Ah
	575 Ah	900 Ah
	575 Ah	900 Ah
	370 Ah	600 Ah
 or 	700 Ah	1100 Ah
	700 Ah	1100 Ah

Warning! 12 V rechargeable batteries must be used.

Battery selection for a solar installation

The battery and solar panels must be selected carefully to suit the energizer's electrical current consumption. As well as the position of the selector switch position, the battery and solar panels you choose will depend on the amount of sunshine at the location of the installation.

As a guide, the minimum amp hour (Ah) rating of the 12 V rechargeable battery required is shown below. This table shows the battery requirements for up to seven days of operation with little or no sunlight. It takes into account the variety of solar panel and regulator types that could be used in a solar installation. For more detailed information, refer to www.tru-test.com.

Selector switch position	Current required (approximately)		Minimum battery capacity (80% discharge)	
	6 J models	12 J models	6 J models	12 J models
	410 mA	700 mA	110 Ah	190 Ah
	410 mA (day) 650 mA (night) 530 mA (24 hour average)	700 mA (day) 1100 mA (night) 900 mA (24 hour average)	140 Ah	240 Ah
	650 mA (day) 410 mA (night) 530 mA (24 hour average)	1100 mA (day) 700 mA (night) 900 mA (24 hour average)	140 Ah	240 Ah
	330 mA	580 mA	85 Ah	150 Ah
	650 mA	1100 mA	170 Ah	290 Ah

Warning! 12 V rechargeable batteries must be used.

Battery management

Warning! Batteries contain harmful chemicals and when used incorrectly, may cause injury. Observe the guidelines for battery care, maintenance and safety in this manual and in the documentation supplied with your battery.

Battery charging

Warning!

- Do not attempt to recharge a non-rechargeable battery.
- When recharging a battery, ensure that there is adequate ventilation to allow gases to disperse.

Regular recharging of the battery is essential. Use a suitable safety approved battery charger and refer to the battery manufacturer's recommendations.

- 1 Attach the positive (+) battery charger lead to the positive terminal of the battery, and the negative (-) battery charger lead to the negative terminal on the battery.
- 2 Connect the battery charger's input power plug to a mains or line socket and turn on the power supply.

Caution! Over-charging the battery will reduce its life. Do not exceed the recommendations of the battery manufacturer on recharging the battery from a mains-powered (line-powered) source.

Battery care and maintenance

- House the battery in a suitably designed battery box, if the battery is likely to be exposed to the weather.

- When not in use, store the battery fully charged and recharge at regular intervals (every 8 weeks).
- Recharge a discharged battery as soon as possible. Batteries should not be left discharged.
- Inspect the battery regularly to ensure that the electrolyte level does not fall below the surface of the battery plates.
- Top up the battery using distilled water. Do not overfill. Refer to the battery manufacturer's recommendations for more information.

Battery safety

- Ensure that the battery is well ventilated when recharging.
- Avoid temperatures greater than 50 °C (120 °F).
- Ensure the battery is not exposed to naked flame or sparks.

Using a remote control handset

12000i, 12000i-EU, X12i, X12i-EU, 412i, 412i-EU, 6000i, 6000i-EU, X6i, X6i-EU, 406i, and 406i-EU energizers will accept commands from a Tru-Test remote control handset. No configuration is required. The energizer and remote control are pre-programmed to communicate.

Note: 6000, 6000-EU, X6, X6-EU, 406 and 406-EU energizers cannot be used with a remote control handset.

Activating the energizer for use with a remote control handset

During the first 10 minutes of operation, the energizer's remote control feature can be activated. During this period, the large arrow on the LCD display flashes to indicate this. The energizer will otherwise operate normally.

To activate the remote control feature, turn off the energizer using a remote control handset (see the remote control handset's user manual for details). The energizer will stop pulsing, and the last green light will flash to indicate that the energizer is in standby mode. The large arrow on the LCD remains on to indicate that activation has been successful.

Once the energizer's remote control feature has been activated, you will not need to perform the activation procedure again.

Note:

- If the energizer is not successfully activated within the first 10 minutes of operation, you will need to switch the energizer off and on before you can try again.
- You can disable the remote control feature at any time. For instructions, see the remote control handset's user manual. If you do not have a remote control handset, take the energizer to an authorised service centre to have the feature disabled.

The remote control handset

The remote control handset is three tools in one. It acts as a:

- Remote control – Switching the energizer on or off from remote locations on the electric fence system.
- Fault finder – Assisting in the location of faults anywhere on the fence system.
- Voltmeter/Ammeter – Providing instant feedback on fence performance (voltage and current)

For detailed instructions on using the remote control handset, refer to the user manual supplied with the handset. Alternatively, the latest copy of the user manual can be downloaded from www.trutest.com.

Warning! The energizer will reactivate following a power failure, even if it was switched off by a remote control handset before the power failure. The fence should be regarded as live at all times, regardless of the energizer switch position or the remote control status. If you are working on a section of fence, isolate the section with a cut-out switch, or disconnect the energizer from its power source.



Building a permanent electric fence

Components of an electric fence

An electric fence system comprises the following elements:

- *An energizer.*
- *An earth system.* This comprises a number of metal rods inserted into the ground, which are connected to the Fence earth terminal on the energizer.
- *Insulated underground cables.* Electric fence wire coated in* insulated plastic, suitable for use underground or going through walls. Used to connect the energizer to the earth and fence.
- *An insulated fence.* Connected to the Fence output terminal of the energizer. Fences can be made to a variety of designs (see below).

Other useful components that can be added:

-  Cut-out switches. Installed at regular intervals, these allow you to isolate sections of the fence for repair.
-  Lightning diverter kit. Used to minimise the damage to your energizer from lightning conducted down the fence line.

Typical installation

The animal receives a shock when it completes a circuit between the fence and the earth system. The fence below has all live wires and requires conductive soils. This type of fence is often referred to as an 'all-live' or 'earth-return' fence.

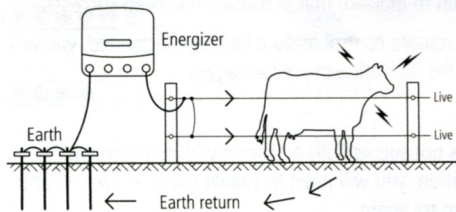

Alternative installation

For poor conductivity soils (dry or sandy), a 'fence-return' or 'earth-wire-return' system is recommended. With this type of fence, the Fence earth terminal is connected directly to at least one non-electrified fence wire (earth wire). The animal gets maximum shock from touching a live wire and an earth wire at the same time.

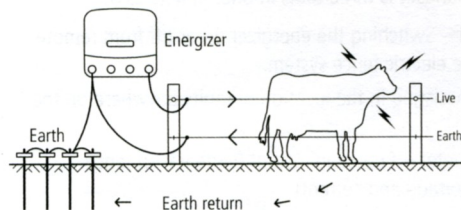

Bi-polar installation

In areas with poor earthing conditions, a 'bi-polar' installation may be used to enhance the performance of the fence. With a bi-polar

installation, all fence wires are insulated. Alternate fence wires are interconnected to form one negatively charged circuit and one positively charged circuit. The energizer passes half the output voltage to the negatively charged wires and half the output voltage to the positively charged wires. The animal gets a shock from touching a positive wire or a negative wire OR, if touching both a positive and negative wire simultaneously it gets a stronger shock.

To construct a bi-polar fence:

- 1 Interconnect fence wires so that there are two different circuits, as shown in the diagram.
- 2 Connect the Fence half voltage terminal (yellow) to the earth system using insulated cable.
- 3 Connect the Fence earth terminal (green) to the negative wires.
- 4 Connect the Fence full voltage terminal (red) to the positive wires.

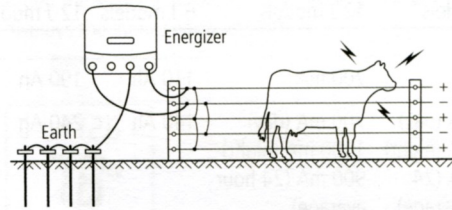

Note: The earth monitoring feature cannot be used with a bi-polar installation.

Reducing the fence voltage output

In some areas, it may be desirable to have a reduced fence voltage output, for example where there is a risk of fire or where there is a chance that people might come into contact with the electric fence (e.g. around a house or next to a public roadway).

To reduce the fence voltage, use the Fence half voltage terminal (yellow) instead of the Fence full voltage terminal to connect the energizer to the fence. See the *Installation section* on page 3.

When the Fence half voltage terminal (yellow) is used, the fence voltage will not exceed 5 kV, however the output power remains the same.

Fence designs

Fences can be constructed to suit the type of livestock and materials available. Discuss with your reseller which design best suits your needs. Some suggested fence configurations are below.

Cattle and horses

10-15 m (33-49') spacing, posts only

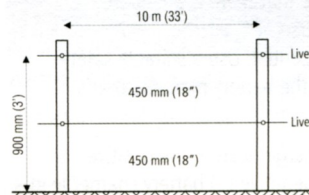

15-20 m (49-65') spacing with droppers

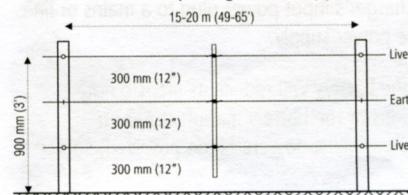

Sheep, goats, cattle and horses

10 m (33') spacing, posts only

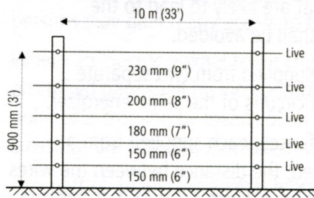

15 m (49') spacing with droppers

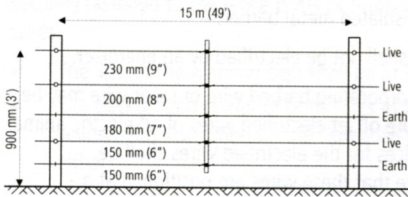

Wild animals

7 wire, 10 m (33') spacing with droppers

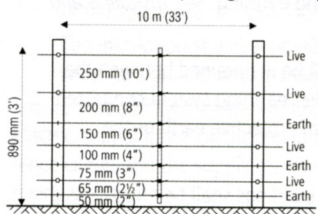

End assemblies

Angle stay

Suitable for field gate, high-tension strainer.

After firmly setting the footed strainer in the ground, dig in the stay block just below ground level, at a distance to ensure the angle stay will be held snugly in position. The stay can be levered into position with a spade.

All-live system

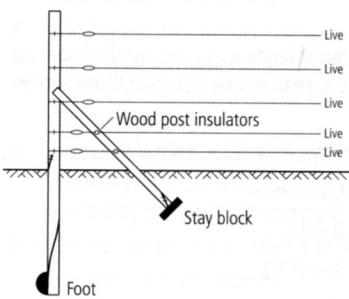

Fence-return system

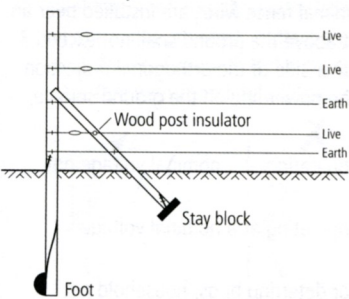

Horizontal stay

Suitable for field gate, high-tension strainer.

Very simple to erect and most suitable as a high tension strainer, excellent in areas where the soil gets very wet or where heavy frost occurs.

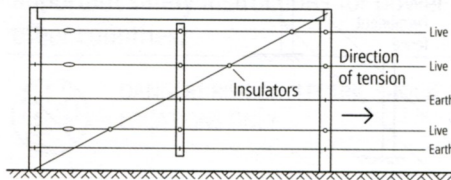

Installing and testing an earth system

Select a suitable site for the earth system. Sites need to be:

- At least 10 m (33') from other earth systems (e.g. telephone, mains power or the earth system of another energizer).
- Away from stock or other traffic that could interfere with the installation.
- At a site that can be easily observed for maintenance.
- Ideally at a site that has damp soil (e.g. a shaded or swampy location). Note that the earth does not need to be directly adjacent to the energizer installation.

Drive four 2 m (6'6") earth rods into the ground. Use high-voltage, insulated cable and earth clamps to continuously connect the earth rods and the energizer's Fence earth terminal. Make sure the insulation is stripped back to ensure good contact between the wire and the earth rod.

Test the earth system, using the following procedure:

- 1 Turn off the energizer.
- 2 At least 100 m (330') away from the energizer, short circuit the fence by laying several steel rods or lengths of pipe against the fence. In dry or sandy conditions, it may be necessary to drive the rods up to 300 mm (12") into the earth.
Note: It is not acceptable to short-circuit a fence return system to the earth wire of the fence.
- 3 Turn the energizer back on.
- 4 Using an electric fence voltmeter, ensure that the fence voltage is below 2 kV.
- 5 *Check your earth system.* Insert the voltmeter's earth probe into the ground at the full extent of the lead, and clip the other lead to the last earth rod. The voltmeter should not read more than 0.8 kV. Anything higher than this indicates that better earthing is required. Either add more earth rods or find a better ground area to drive in the earth rods.

Note: When earthing energizers located in dairies, earth at least 20 m (65') away from the dairy using double-insulated lead-out wire to avoid touching the dairy building or equipment.

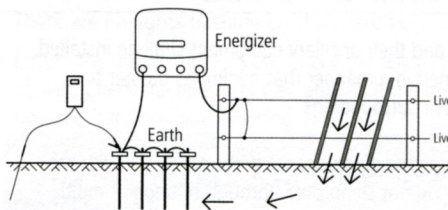

Temporary electric fencing

A temporary fence can be quickly erected and easily moved allowing the farmer to:

- Make smaller paddocks (fields)
- Keep herds of animals separated
- Ration feed

Note: Use more wires for smaller animals and wild animals. Politape should be used when greater visibility is required (e.g. horses).

An example of a temporary fence is shown below.

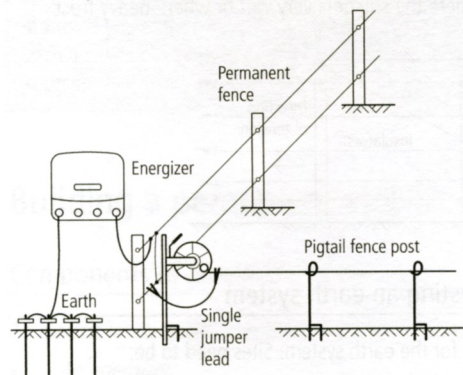

Safety considerations

Definition of special terms

Energizer – An appliance that is intended to periodically deliver voltage impulses to a fence connected to it.

Fence – A barrier for animals or for the purpose of security, comprising one or more conductors such as metal wires, rods or rails.

Electric fence – A barrier which includes one or more electric conductors, insulated from earth, to which electric pulses are applied by an energizer.

Fence circuit – All conductive parts or components within an energizer that are connected or are intended to be connected, galvanically, to the output terminals.

Earth electrode – Metal structure that is driven into the ground near an energizer and connected electrically to the Fence earth terminal of the energizer, and that is independent of other earthing arrangements.

Connecting lead – An electric conductor, used to connect the energizer to the electric fence or the earth electrode.

Electric animal fence – An electric fence used to contain animals within or exclude animals from a particular area.

Electric security fence – A fence used for security purposes which comprises an electric fence and a physical barrier electrically isolated from the electric fence.

Physical barrier – A barrier not less than 1.5 m (5') high intended to prevent inadvertent contact with the pulsed conductors of the electric fence. Physical barriers are typically constructed from vertical sheeting, rigid vertical bars, rigid mesh, rods or chainwire mesh.

Requirements for electric animal fences

Electric animal fences and their ancillary equipment shall be installed, operated and maintained in a manner that minimises danger to persons, animals or their surroundings.

Warning! Avoid contacting electric fence wires especially with the head, neck or torso. Do not climb over, through or under a multi-wire electric fence. Use a gate or a specially designed crossing point.

This energizer is not intended for use by persons (including children) with reduced physical, sensory or mental capabilities, or lack of experience and knowledge, unless they have been given supervision or instruction concerning use of the energizer by a person responsible for their safety.

Children should be supervised to ensure that they do not play with the energizer.

Electric animal fence constructions that are likely to lead to the entanglement of animals or persons shall be avoided.

An electric animal fence shall not be supplied from two separate energizers or from independent fence circuits of the same energizer.

For any two separate electric animal fences, each supplied from a separate energizer independently timed, the distance between the wires of the two electric animal fences shall be at least 2.5 m (8'). If this gap is to be closed, this shall be effected by means of electrically non-conductive material or an isolated metal barrier.

Barbed wire or razor wire shall not be electrified by an energizer.

A non-electrified fence incorporating barbed wire or razor wire may be used to support one or more offset electrified wires of an electric animal fence. The supporting devices for the electrified wires shall be constructed so as to ensure that these wires are positioned at a minimum distance of 150 mm (6") from the vertical plane of the non-electrified wires. The barbed wire and razor wire shall be earthed at regular intervals.

Follow our recommendations regarding earthing. See *Installing and testing an earth system* on page 9.

A distance of at least 10 m (33') shall be maintained between the energizer earth electrode and any other earthing system connected parts such as the power supply system protective earth or the telecommunication system earth.

Connecting leads that are run inside buildings shall be effectively insulated from the earthed structural parts of the building. This may be achieved by using insulated high voltage cable.

Connecting leads that are run underground shall be run in conduit of insulating material or else insulated high voltage cable shall be used. Care must be taken to avoid damage to the connecting leads due to the effects of animal hooves or vehicle wheels sinking into the ground.

Connecting leads shall not be installed in the same conduit as the mains supply wiring, communication cables or data cables.

Connecting leads and electric animal fence wires shall not cross above overhead power or communication lines.

Crossings with overhead power lines shall be avoided wherever possible. If such a crossing cannot be avoided it shall be made underneath the power line and as nearly as possible at right angles to it.

If connecting leads and electric animal fence wires are installed near an overhead power line, the clearances shall not be less than those shown in the table below.

Minimum clearances from power lines for electric animal fences

Power line voltage	Clearance
≤1000 V	3 m (10')
>1000 V to ≤33,000 V	4 m (13')
>33,000 V	8 m (27')

If connecting leads and electric animal fence wires are installed near an overhead power line, their height above the ground shall not exceed 3 m (10'). This height applies to either side of the orthogonal projection of the outermost conductors of the power line on the ground surface, for a distance of:

- 2 m (6'6") for power lines operating at a nominal voltage not exceeding 1000 V.
- 15 m (50') for power lines operating at a nominal voltage exceeding 1000 V.

Electric animal fences intended for deterring birds, household pet containment or training animals such as cows need only be supplied from low output energizers to obtain satisfactory and safe performance.

In electric animal fences intended for deterring birds from roosting on buildings, no electric fence wire shall be connected to the energizer earth electrode. A warning sign shall be fitted to every point where persons may gain ready access to the conductors.

Where an electric animal fence crosses a public pathway, a non-electrified gate shall be incorporated in the electric animal fence at that point or a crossing by means of stiles shall be provided. At any such crossing, the adjacent electrified wires shall carry warning signs.

Any part of an electric animal fence that is installed along a public road or pathway shall be identified at frequent intervals by warning signs securely fastened to the fence posts or firmly clamped to the fence wires.

- The size of the warning sign shall be at least 100x200 mm (4x8").
- The background colour of both sides of the warning sign shall be yellow. The inscription on the sign shall be black and shall be either:



or the substance of "CAUTION: Electric fence".

- The inscription shall be indelible, inscribed on both sides of the warning sign and have a height of at least 25 mm (1").

Ensure that all mains-operated, ancillary equipment connected to the electric animal fence circuit provides a degree of isolation between the fence circuit and the supply mains equivalent to that provided by the energizer.

Protection from the weather shall be provided for the ancillary equipment unless this equipment is certified by the manufacturer as being suitable for use outdoors, and is of a type with a minimum degree of protection IPX4.

Important safety instructions for Class 2 power units (USA/Canada only)

When using electrical products, basic precautions should always be practiced including the following:

- 1 READ AND FOLLOW ALL SAFETY INSTRUCTIONS
- 2 Read and follow all instructions that are on the product or provided with the product.
- 3 Do not use an extension cord.
- 4 Reference the National Electrical Code, ANSI/NFPA 70, specifically for the installation of wiring and clearances from power and lighting conductors.
- 5 Installation work and electrical wiring must be done by qualified person(s) in accordance with all applicable codes and standards, including fire-rated construction.
- 6 Do not install or use within 3 m (10') of a pool.
- 7 Do not use in a bathroom.
- 8 **WARNING: Risk of Electric Shock.** When used outdoors, install only to a covered Class A GFCI protected receptacle that is weatherproof with the power adaptor connected to the receptacle. If one is not provided, contact a qualified electrician for proper installation. Ensure that the power adaptor and cord do not interfere with completely closing the receptacle cover.

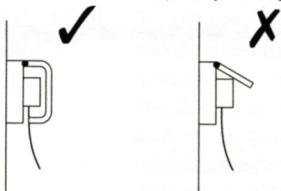

- 9 **WARNING: Risk of Fire.** Installation involves special wiring methods to run wiring through a building structure. Consult a qualified electrician.

- 10 **WARNING: Risk of Electric Shock.** Mount the unit at a height greater than 30 cm (1') from the ground surface.
- 11 **SAVE THESE INSTRUCTIONS** – This manual contains important safety and operating instructions for power adaptors.

Important safety instructions for power adaptors (all other countries)



DANGER! RISK OF ELECTRIC SHOCK. INDOOR DRY LOCATIONS ONLY.

Frequently asked questions/Troubleshooting

What voltage is required to control animals?

4 kV is widely accepted as an adequate voltage to control animals. However, you also require a well constructed fence system to ensure that animals cannot push through electrified wires.

The fence voltage is below 4 kV. How do I increase the voltage?

Check the energizer. Ensure that the energizer is on and set to operate at full power. Disconnect the fence wire from the energizer's fence output terminal. Measure the voltage across the energizer terminals using a Fault Finder, Digital Voltmeter or a remote control handset. If the voltage is less than 6 kV, the energizer may require servicing.

Check the energizer earthing. For 12000i, 12000i-EU, X12i, X12i-EU, 412i, 412i-EU, 6000i, 6000i-EU, X6i, X6i-EU, 406i and 406i-EU energizers, check that the earth monitor voltage on the LCD display is below 0.8 kV, see *Earth monitoring* on page 5. For 6000, 6000-EU, X6, X6-EU, 406 and 406-EU energizers, use the procedure described in *Installing and testing an earth system* on page 9.

Check the fence system for faults. The most common source of low voltage is faults on the fence line.

If the fence, earth and energizer are in good condition and the voltage is still below 4 kV, talk to your nearest reseller. Recent extensions to your fence, a poor fence layout, or soil conditions may be causing inadequate voltage.

How do I locate faults?

The recommended tool for locating faults is a Fault Finder or remote control handset. These have a combined voltage and current meter which allows you to rapidly locate sources of current leakage. Alternatively, use a Digital Voltmeter. Use cut-out switches to turn off the power to different sections of the farm. If the voltage on the fence increases when a section of the farm is turned off, then investigate that section for possible faults.

There are no lights flashing on the energizer

Ensure the power supply is on. Check the fence system for faults (see above). Check the energizer (see above). If the energizer still does not operate, it may require servicing.

The energizer does not respond to commands from the remote control handset

See the Frequently Asked Questions/Troubleshooting section in the remote control handset's user manual.

I want to disable the energizer's remote control feature

If you have a remote control handset, see the remote control handset's user manual for instructions. If not, take the energizer to an authorised service centre to have the feature disabled.

Identifying faults using the LCD display and the indicator lights

If...	This means that...
The energizer is not pulsing and the first red Indicator light is flashing...	The battery connections may be faulty. Check all battery connections. Check the battery voltage immediately using the battery test setting. See <i>Testing the battery voltage</i> on page 6.
The first red Indicator light is flashing and other indicator lights are on...	The energizer has a fault. If the display persists and does not return to normal, contact your service agent for advice.
The energizer is pulsing slowly and has a reduced output voltage...	The battery voltage may be low and the energizer has reverted to Slow Speed and Low Output Power in order to preserve the remaining power and energy in the battery.
<i>(12000i-EU, X12i-EU, 412i-EU, 6000i-EU, X6i-EU, 406i-EU, 6000-EU, X6-EU and 406-EU energizers only)</i> The warning light is flashing and a warning buzzer is sounding...	The energizer has detected a sudden increase in the load on the fence. Switch the energizer off, locate and remedy fault then turn the energizer on again. For example, this may occur: <ul style="list-style-type: none"> if a cutout switch is closed, connecting a heavily loaded section of the fence to the energizer if a branch falls on the fence if the fence or cable connecting energizer to it experiences a sudden short to ground if something becomes entangled in the fence.
<i>(12000i, 12000i-EU, X12i, X12i-EU, 412i, 412i-EU, 6000i, 6000i-EU, X6i, X6i-EU, 406i and 406i-EU energizers only)</i> The output voltage digits (large digits on the LCD display) flash 1.0 kV...	The fence voltage is below 1000 V. There is a serious fault on the fence line. See "How do I locate faults?" in <i>Frequently asked questions/Troubleshooting</i> on page 11.
<i>(12000i, 12000i-EU, X12i, X12i-EU, 412i, 412i-EU, 6000i, 6000i-EU, X6i, X6i-EU, 406i and 406i-EU energizers only)</i> The first red Indicator light is illuminated permanently...	The earth monitor voltage is too high. Use the earth monitoring feature to monitor the earth. See <i>Earth monitoring</i> on page 5.
<i>(12000i, 12000i-EU, X12i, X12i-EU, 412i, 412i-EU, 6000i, 6000i-EU, X6i, X6i-EU, 406i and 406i-EU energizers only)</i> The battery symbol on the LCD is flashing...	The battery voltage is bad. Check the battery voltage immediately, using the battery test setting. See <i>Testing the battery voltage</i> on page 6.
<i>(12000i, 12000i-EU, X12i, X12i-EU, 412i, 412i-EU, 6000i, 6000i-EU, X6i, X6i-EU, 406i and 406i-EU energizers only)</i> The right arrow on the LCD is flashing...	During the first 10 minutes of operation, the energizer's remote control feature can be activated. During this period, the large arrow on the LCD display flashes to indicate this. This occurs each time the energizer is switched on when the energizer's remote control feature has not been activated. This is part of normal operation.

If...	This means that...
<i>(12000i, 12000i-EU, X12i, X12i-EU, 412i, 412i-EU, 6000i, 6000i-EU, X6i, X6i-EU, 406i and 406i-EU energizers only)</i> The energizer is not pulsing and the last green Indicator light is flashing...	The energizer has been switched off by a remote control handset. If you think your energizer might be being controlled by a neighbour's remote control handset and you own a remote control handset yourself, change your energizer's address setting (see the remote control handset's user manual). If you do not have a remote control handset, take the energizer to an authorised service centre to have the remote control feature disabled.

Servicing

This energizer uses Double Insulation, where two systems of insulation are provided instead of grounding. No equipment grounding means is provided in the supply cord of a double-insulated energizer, nor should a means for equipment grounding be added to the energizer. Servicing a double-insulated energizer requires extreme care and knowledge of the system and should only be done by qualified service personnel. Replacement parts for a double-insulated energizer must be identical to the parts they replace. A double-insulated energizer is marked with the words DOUBLE INSULATION or DOUBLE INSULATED and/or the symbol below.



Product specifications

	6 J models	12 J models
Power supply	12 V battery, or approved power adaptor 100-240 V	
Power consumption using a power adaptor	10 W	15 W
Current consumption using a 12 V rechargeable battery		
Battery Test	410 mA	700 mA
Slow Speed-Day/ Fast Speed-Night	410 mA (day) 650 mA (night) or 530 mA (24 hour average)	700 mA (day) 1100 mA (night) or 900 mA (24 hour average)
Fast Speed-Day/ Slow Speed-Night	650 mA (day) 410 mA (night) or 530 mA (24 hour average)	1100 mA (day) 700 mA (night) or 900 mA (24 hour average)
Half Output Power	330 mA	580 mA
Full Output Power	650 mA	1100 mA
Maximum output voltage	9.5 kV	9.2 kV
Maximum output energy	6.2 J at 100 Ω	12.4 J at 75 Ω
Maximum stored energy	9 J	16 J

Values are typical and normal production tolerances of ±10% should be allowed for.